MULTI SPLIT

2 0 1 9

LG HVAC SOLUTION



LG Electronics

<http://www.lg.com>
<http://partner.lge.com>

Copyright © 2018 LG Electronics. All rights reserved.

Distributed by



GLOBAL PRODUCTION SITE

LATIN AMERICA SALES INFRASTRUCTURE





TOTAL HVAC SOLUTION PROVIDER

The LG Electronics Air Solution Business Unit is a provider of total HVAC and energy solution. The company offers a broad portfolio of air conditioner products that are compatible with any building anywhere, including compact residences, towering skyscrapers, massive factories and giant concert halls. As a true total HVAC and energy solution provider, LG also supplies even the largest buildings and industrial facilities with central air conditioning systems such as chillers and efficient control solutions.

The history of the business unit goes back to 1968, when LG (then called GoldStar) rolled out Korea's first residential air conditioner. As the company first began making chillers for large commercial buildings in 1970, the commercial air conditioning business has grown

exponentially, especially within the last 20 years. In 2008, LG sold its 100 millionth air conditioning unit, becoming the first company in the industry to reach that significant milestone. The success of LG air conditioners has allowed the company to become one of the major players in the highly competitive HVAC industry. By enhancing the industry's B2B infrastructure and finding further solutions for the HVAC sector, LG has risen to become a total HVAC solutions specialist. The company has steadily increased its sales and market share by introducing energy efficient and reliable HVAC solutions and actively pursuing new opportunities wherever they arise. This sustained, excellent performance is built on a solid foundation of global R&D and advanced manufacturing capabilities.

-  National Sales Office
-  Local Sales Office
-  Production Site

INDEX

08-57 MULTI SPLIT

MULTI SPLIT	06	CEILING MOUNTED CASSETTE (1WAY)	36
LINE-UP	08	CEILING MOUNTED CASSETTE (4WAY)	38
FEATURE OVERVIEW	09	CEILING CONCEALED DUCT	40
KEY FEATURES	10	ACCESSORIES	42
OUTDOOR UNITS	23	INDIVIDUAL CONTROL SOLUTION	44
WALL MOUNTED UNITS	30	COMBINATION TABLE	50



58-65 MULTI STANDARD

INDOOR UNITS KEY FEATURES	59
OUTDOOR UNITS KEY FEATURES	62
INDOOR UNITS	64
OUTDOOR UNITS	65



MULTI SPLIT





LINE-UP

INDOOR UNIT

		kBtu/h	7	9	12	18	24
		kW	2.1	2.6	3.5	5.3	7.0
WALL MOUNTED UNITS	ARTCOOL 		AMNW07GSJR0	AMNW09GSJR0	AMNW12GSJR0	AMNW18GSKR0	AMNW24GSKR0
	Standard 		AMNW07GSJA0	AMNW09GSJA0	AMNW12GSJA0	AMNW18GSKA0	AMNW24GSKA0
Ceiling Mounted Cassette	1 Way Cassette 			AMNW09GTUC0	AMNW12GTUC0		
	4 Way Cassette 			AMNW09GTRA1	AMNW12GTRA1	AMNW18GTQA1	AMNW24GTPA1
Ceiling Concealed Duct	Mid / High Static Pressure 					AMNW18GM1A0	AMNW24GM1A0
	Low Static Pressure 			AMNW09GL1A2	AMNW12GL2A2	AMNW18GL2A2	AMNW24GL3A2

OUTDOOR UNIT

		kBtu/h	16	21	30	40	48	57
		kW	4.7	6.2	8.8	11.7	14.1	16.7
Multi	Multi Piping 		A2UW16GFA2 2-port	A3UW21GFA2 3-port	A5UW30GFA2 5-port	A5UW40GFA0 5-port		
	Distribution Box 					A7UW40GFA0 7-IDU	A8UW48GFA0 8-IDU	A9UW56GFA0 9-IDU

FEATURE OVERVIEW

Category	MULTI PIPING				DB BOX TYPE		
kBtu/h	16	21	30	40	40	48	57
kW	4.7	6.2	8.8	11.7	11.7	14.1	16.7
Energy Efficiency	BLDC Comp. & Fan Motor	•	•	•	•	•	•
	Wide Louver Plus Fin	•	•	•	•	•	•
	Optimised Heat Exchanger Path	•	•	•	•	•	•
	Smart Load Control		•	•	•	•	
	Peak Current Control	•	•	•	•	•	•
	Standby Mode	•	•	•			
Durability	Mode Lock	•	•	•	•	•	•
	Twin Rotary Compressor	•	•	•	•	•	•
	Smart Sensor Pressure Control		•	•	•	•	•
Comfort & Convenience	Ocean Black Fin Heat Exchanger	•	•	•	•	•	•
	Fast Cooling & Heating		•	•	•	•	•
	Night Silent Operation	•	•	•	•	•	•
	Wiring Error Check	•	•	•	•	•	•
	Monitoring PCB	•	•				
	LG MV	•	•	•	•	•	•
Forced Cooling Operation	•	•	•	•	•	•	

KEY FEATURES

PERFECT SOLUTION FOR MULTIPLE ROOMS



Energy Efficiency | Extreme Durability | Comfort and Convenience

LG Multi split system provides powerful, efficient cooling and heating with two, three, four, or up to nine indoor units operating off a single outdoor unit.

LG's advanced inverter technology brings powerful performance while consuming less energy and it uses less space than installing individual single split systems.

A variety of sleek and elegant indoor units to complement any décor are available in a full range of capacities for all room sizes.

Installation is easy and it offers various convenient functions for easy maintenance.



ENERGY EFFICIENCY

ENERGY EFFICIENCY

The advanced technologies of LG achieve the lowest energy consumption, especially SEER value regarding ErP regulation.

World Class High Efficiency

SEER 8.5

SEER / SCOP class (ErP regulation)							
kW	4.1	4.7	5.3	6.2	7.0	7.9	8.8
SEER	8.5	7.8	8.5	8.5	8.2	8.0	8.2
	A+++	A++	A+++	A+++	A++	A++	A++
SCOP	4.2	4.2	4.2	4.2	4.2	4.2	4.2
	A+	A+	A+	A+	A+	A+	A+

- BLDC Inverter Twin Rotary Compressor
- Enhanced Heat Exchanger
- Smart Load Control
- Peak current control

Powerful BLDC (Brushless Direct Current Motor) Compressor

LG air conditioners are equipped with a BLDC Inverter Twin Rotary Compressor that uses a neodymium magnetic core. The compressor has high efficiency and superior reliability, because it is excellent in controlling the operating speed depending on the load. The compressor has improved efficiency compared to standard AC inverter products and optimized for changes of outdoor load. Especially it is optimized for seasonal efficiency.

• Operation Range

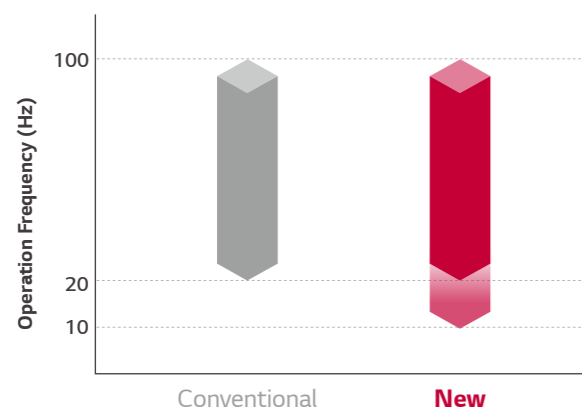

• Motor Efficiency

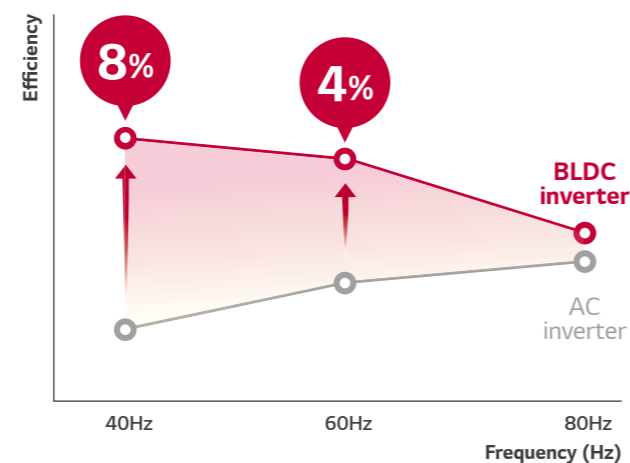

Enhanced Heat exchange by Wide Louver Plus Fin

Wide Louver Plus fin technology increases 11% of full load heating performance and 6% of COP compared to conventional fin. It can slow down frosting of heat exchanger and postpone the start of defrosting operation.

• Why?

The flat area ("+" shape) and the area occupied by the louver are optimized to reduce pressure loss while preventing heat exchange performance from dropping. Even if frost occurs, the heat transfer can be made longer than conventional fin due to the reduced pressure loss, which increases the heating operation time.

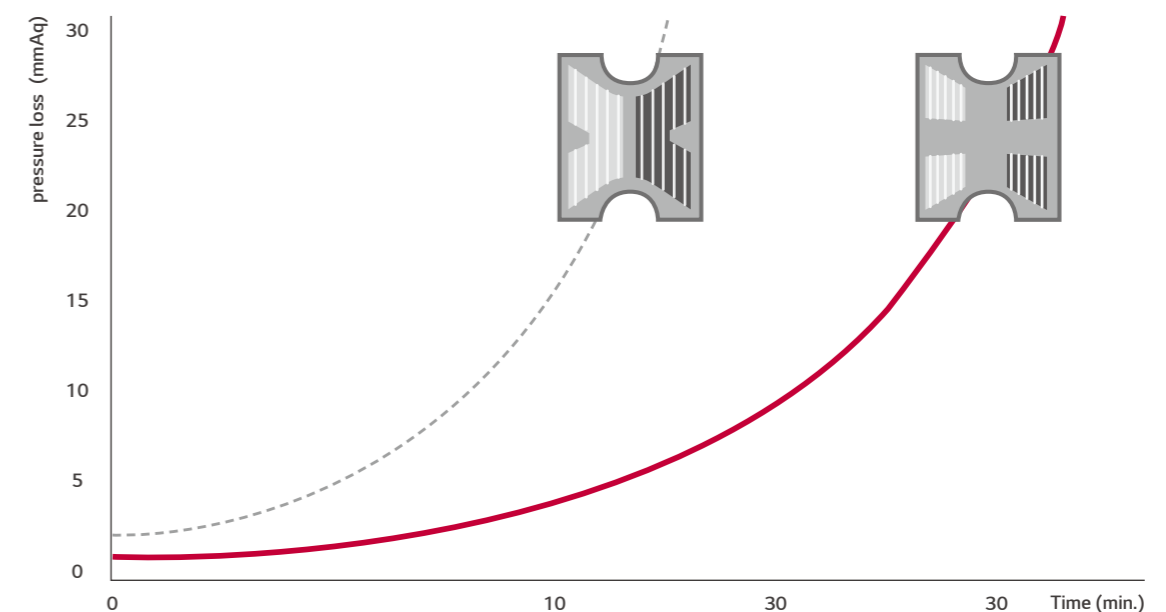
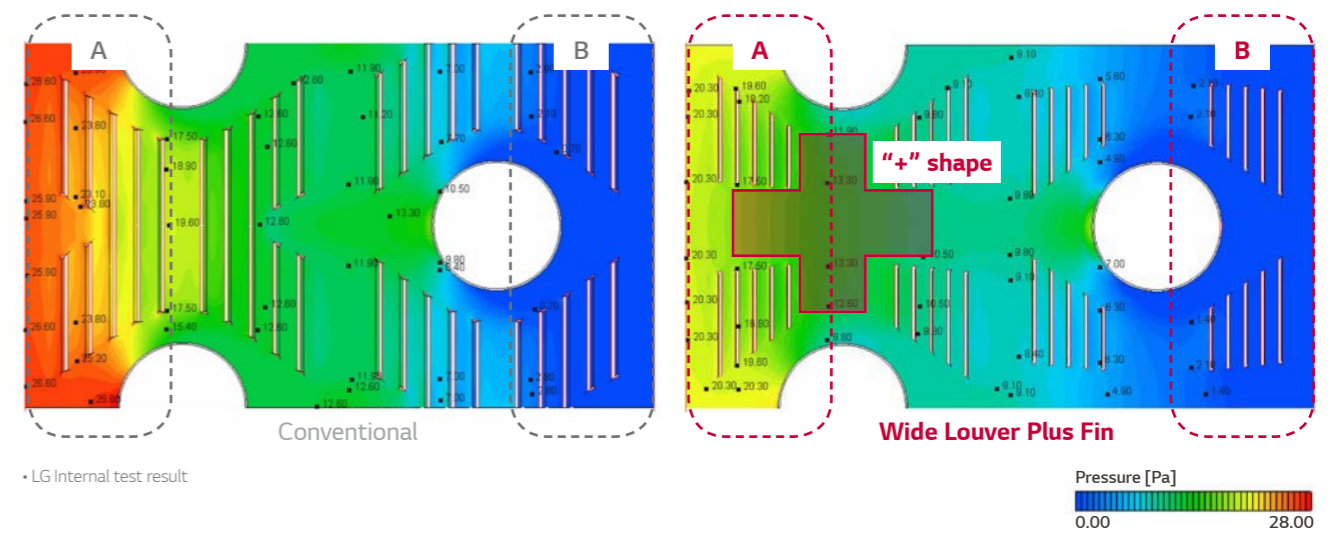

Pressure (Pa)	A	B	Pressure Loss (A-B)
Conventional	25.5	2.0	23.5
Wide Louver Plus Fin	19.5	1.8	17.7

ENERGY EFFICIENCY

Smart Load Control

To save operation energy, it automatically controls the refrigerant temperature according to outside temperature.

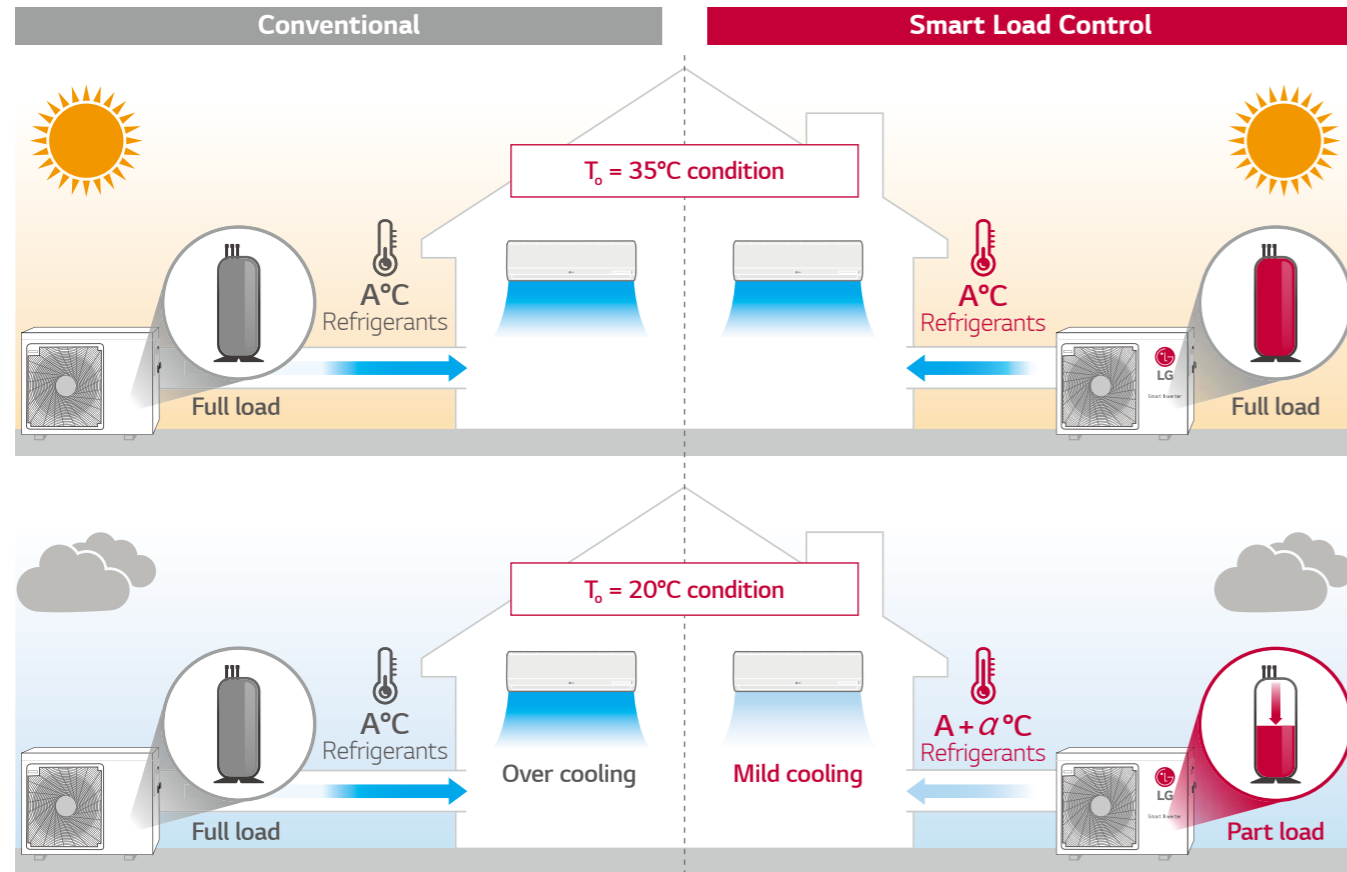

* T_o : Outdoor temperature
* A is the indoor unit coil temperature

• How to set dip switch

To operate smart load control, dip switch setting is needed. It can save energy on real time operation.

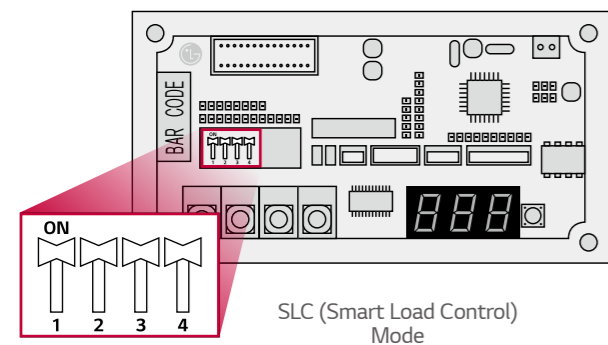

• Real Time Energy Saving

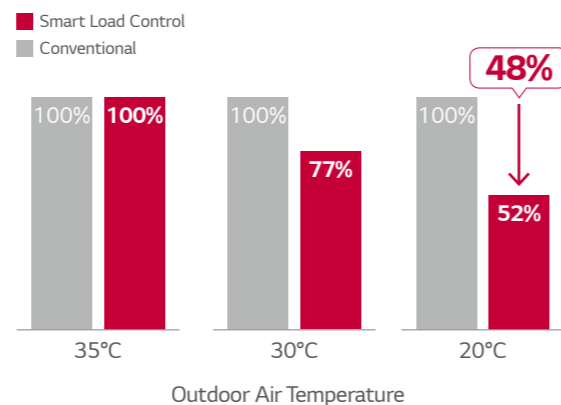

* Applied models : MU3R19 UE0 / MU3R21 UE0 / MU4R25 U40 / MU4R27 U40 / MU5R30 U40 / MU3M19 UE4 / MU3M21 UE4 / MU4M25 U44 / MU5M30 U44 / MU5M40 U02

Peak Current Control

The peak current control function keeps the air conditioner from running at the maximum level while maintaining current system setting, in order to reduce energy consumption. This function can help to cut energy costs during the peak periods of energy use when the energy fee is much higher.

• How to set dip switch

STEP 1 Max power consumption : 1.9 kW

STEP 2 Max power consumption : 1.7 kW

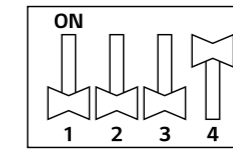
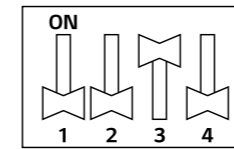

* Full Load consumption : 2.5kW
* 7.0kW model
* LG Internal test result

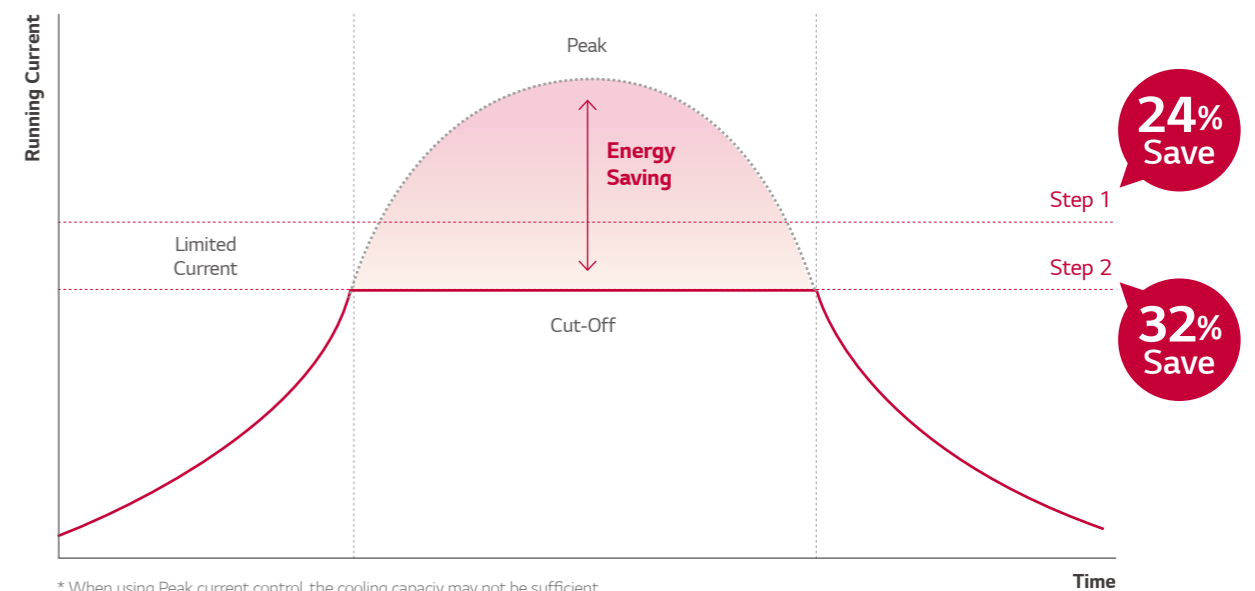

* When using Peak current control, the cooling capacity may not be sufficient.
* 7.0kW model
* LG Internal test result

EXTREME DURABILITY

EXTREME DURABILITY

Product safety is emphasized by offering a 10-year warranty on the compressor to reassure customers about product durability.

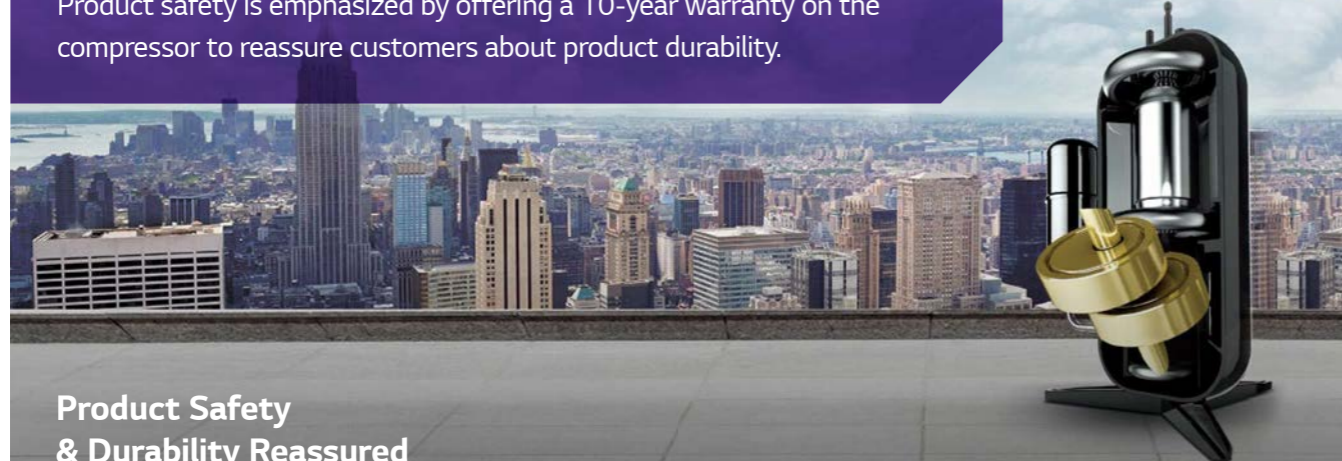

Product Safety & Durability Reassured

- Improved BLDC Inverter Twin Rotary compressor
- Smart Sensor
- Black Fin Heat Exchanger

Pressure Control Technology by Smart Sensor

Quicker and more reliable operation is possible from pressure control technology.

• Field Failure Rate of Outdoor unit

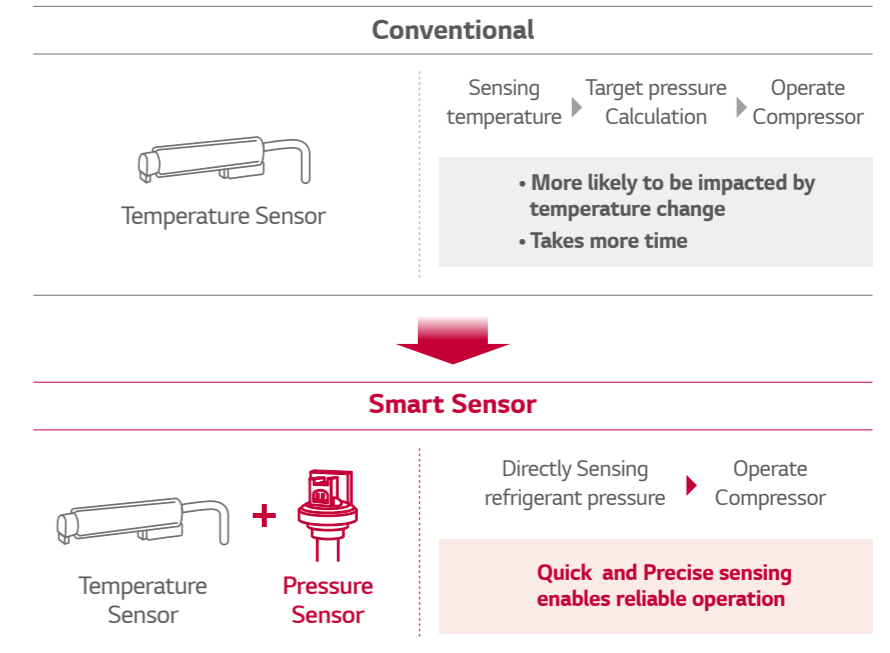
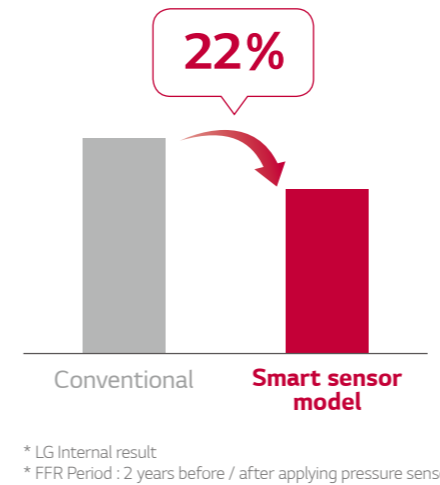

Improved BLDC Inverter Twin Rotary Compressor

Parts of BLDC Inverter Twin Rotary Compressor have been improved to allow for a longer life span.

Flow Optimization

Reduced oil inflow by increasing the length of oil discharge pipe, which remains enough oil inside the compressor to prevent compressor abrasion.

Concentrated Winding Motor

Oil path area is improved by over 50% by increasing the extra stator cavity. Due to this, caloric value of motor is reduced, improving the cooling function of stator coil.

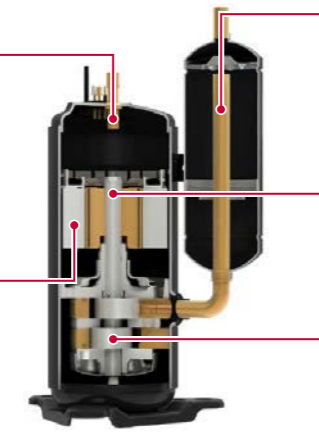

Twin Rotary Inverter Compressor

Suction Optimization

Reduced suction loss and improving oil collection through the optimization of suction path.

Surface Coating

Shaft coating and polishing has been improved.

Twin Rotary Rotor

- Upper and lower part rotor offset imbalance in shaft rotor rotation. Max Torque has been decreased by 45% compared to single rotor.
- Vibration and noise is also reduced.

Black Fin Heat Exchanger

The black coating with enhanced epoxy resin is applied for strong protection from various corrosive external conditions such as salt contamination and air pollution including fumes from factories. Moreover, the hydrophilic film keeps water from accumulating on the heat exchanger's fin, minimizing moisture buildup and eventually making it even more corrosion resistant.

Hydrophilic film (Water flow)

The Hydrophilic coating minimizes moisture buildup on the fin.

Epoxy resin (Corrosion resistant)

The Black coating provides strong protection from corrosion.

Aluminum fin

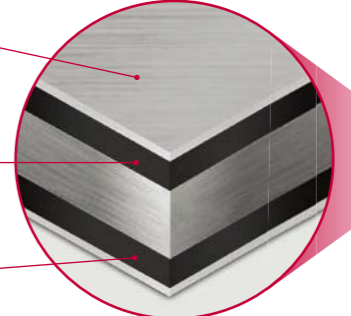

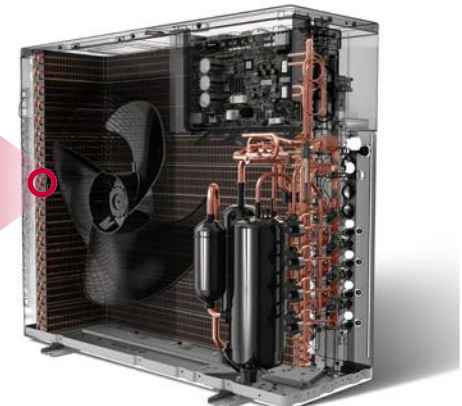

COMFORT AND CONVENIENCE



COMFORT AND CONVENIENCE

LG air conditioner always provides users with maximum levels of comfort and it is designed for an easy and efficient installation.

- Fast cooling and heating
- Night Silent operation
- Easy installation and maintenance

Night Silent Operation

Night silent operation can reduce noise levels at night time by simply setting the dip switch on the PCB of the outdoor unit.

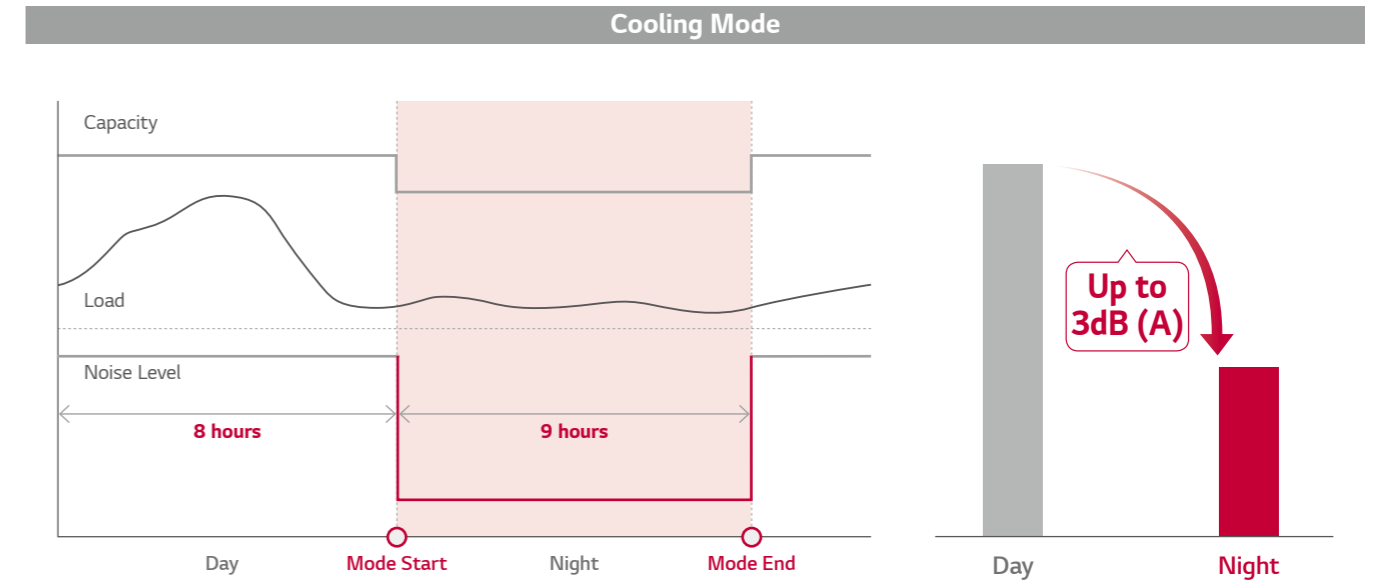

Fast Cooling & Heating

Pressure control takes less time to reach the desired temperature up to 30% in cooling and 44% in heating with high level of accuracy and stability.

• Cooling

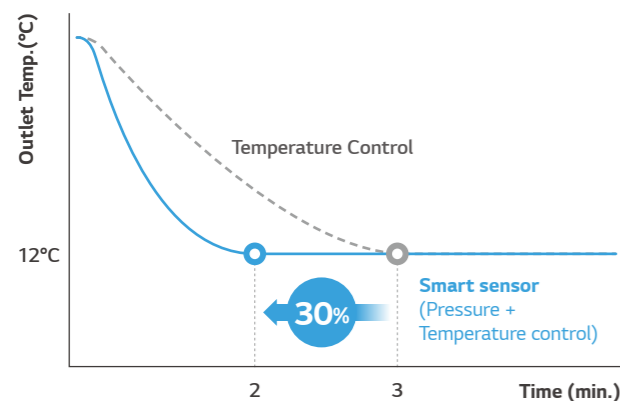

• Heating

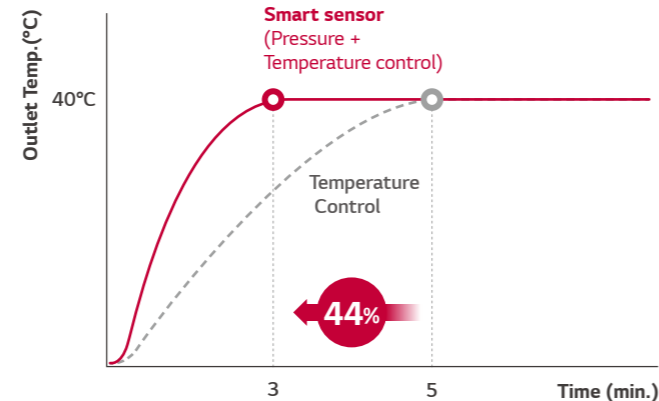

* LGInternal test result

Wiring Error Check

Installers can check whether the transmission cable has been connected correctly by using the wiring error check function. The wiring error check function can reduce the time taken to check for transmission cable errors.

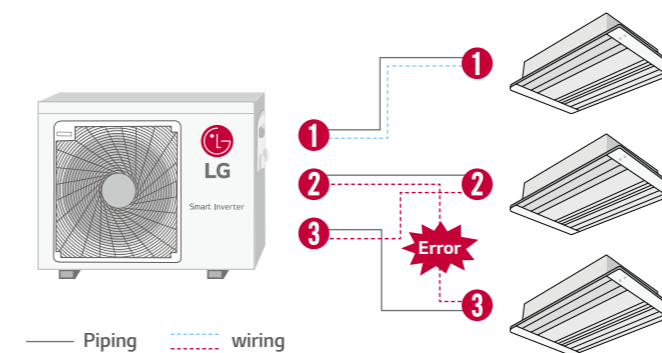

* How to set dip switch

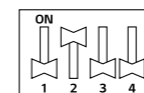

• LED Result

- If the wiring is correct, the Green LED will light up.
- If the wiring is wrong, display as below
 - Red LED : Piping Number
 - Green LED : Wiring Number (Room)

Ex) If the Red LED blinks twice and the Green LED blinks 3 times, 2nd pipe is connected to 3rd room

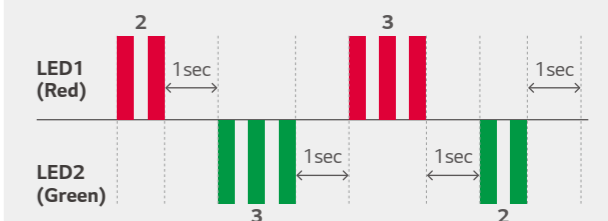

COMFORT AND CONVENIENCE

Monitoring PCB

If there is any problem, without disassembly of chassis, engineers can quickly check air conditioner's error code through 7-segment error indicator

Conventional

Many tools are needed for checking cycle data.

Monitoring PCB

Easy & Quick cycle data Check by Monitoring PCB

• UL4, UE4 chassis

STEP 1
Opening the control cover

3 SCREW

STEP 2
Simply Checking the data on PCB

7-segment error indicator

STEP 3
Displayed Error code sample

0.5 sec off ↑ ↓ 0.5 sec off

• Displayed Error code

Error Code	Contents	Case of Error	Outdoor Status
21	DC Link Peak (IPM Fault)	Over Rated Current	Off
22	CT 2 (Max CT)	Input Over Current	Off
23	DC Link Low Volt.	DC Link Volt is below 140V dc	Off
	DC Link High Volt.	DC Link Volt is above 420V dc	
25	Low Voltage / Over Voltage	Abnomal AC volt Input	Off
26	DC Compressor Position Error	Compressor Starting Fall Error	Off
27	PSC / PFC Fault Error	Over inverter PCB input Current	Off
29	COMP Over Current	Over inverter Compressor Current	Off

* Applied models : A2UW1 6GFA2 (Multi F) / A3UW21GFA2 (Multi F)

LG MV (Monitoring View)

LG MV helps engineers to inspect and monitor air conditioning units easily.

Mobile MV

PC based LGMV
(for service)

Operation information

Cycle View

IDU & ODU Information

Cycle & Valves

Sensors & Electricity

Cycle Diagram

Actuavtor Informationv

Forced Cooling Operation

The forced cooling operation allows refrigerant to be recharged or pumped down, regardless of the indoor temperature. More importantly this function can be used when indoor units are being moved or repaired.

Recharging

1 Close liquid valve
2 Close gas valve

Pump Down

MULTI SPLIT

OUTDOOR UNITS



MULTI SPLIT OUTDOOR UNITS

A2UW16GFA2



LG participates in the ECP programme for EUROVENT AC program.
Check ongoing validity of certification
:www.eurovent-certification.com

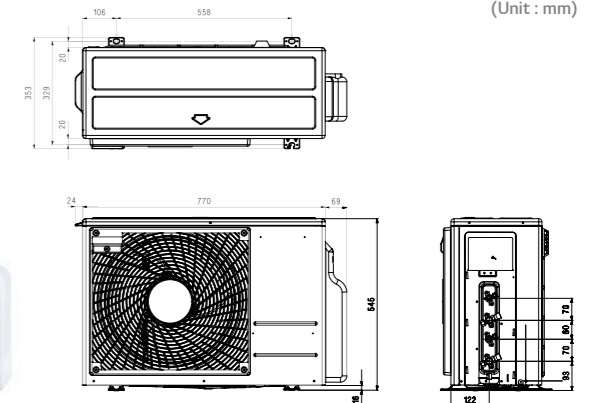

OUTDOOR UNIT				A2UW16GFA2
Compressor	Type			Twin Rotary
Capacity *	Cooling	Min / Nom / Max	kW	0.9 / 4.7 / 5.4
	Heating	Min / Nom / Max	kW	1.0 / 5.3 / 5.7
Low Temperature Capacity	Heating -7°C	Max	kW	3.7
Power Input *	Cooling	Min / Nom / Max	kW	0.2 / 1.3 / 1.7
	Heating	Min / Nom / Max	kW	0.2 / 1.2 / 1.7
Running Current	Cooling	Min / Nom / Max	A	1.1 / 5.6 / 7.9
	Heating	Min / Nom / Max	A	1.1 / 5.5 / 7.6
EER				3.75
COP				4.25
SEER				7.50
SCOP				4.20
Pdesign (@-10°C)				4.1
Seasonal Energy Label	Cooling / Heating (A++ to E Scale)			A++ / A+
Annual Energy Consumption	Cooling / Heating			219 / 1,367
Airflow Rate	Nom			m ³ /min
Sound Pressure	Cooling	Nom	dBA	28.2
	Heating	Nom	dBA	48
Sound Power	Cooling	Max	dBA	51
	Heating	Max	dBA	63
Dimensions	W x H x D			mm
Net Weight				770 x 545 x 288
				Kg
Operation Range (Outdoor)	Charge			Kg
	Additional Charge			1.4
	GWP			20
	t-CO ₂ eq			2,087.5
Operation Range (Outdoor)	Cooling	Min - Max	°C DB	2.9
	Heating	Min - Max	°C WB	-10 ~ 48
Power Supply				-18 ~ 18
Power Supply Cable				Ø / V / Hz
Transmission Cable				1 / 220-240 / 50
Circuit Breaker				No. x mm ²
Piping Length Total				3C x 2.5
Piping Length per Branch				No. x mm ²
				4C x 0.75
Piping Elevation Difference				A
	IDU - ODU	Max	m	15
Piping Connection	IDU - IDU	Max	m	30
				7.5
Piping Connection	Liquid			mm(inch) x No.
	Gas			mm(inch) x No.
				Ø6.35 (1/4) x 2
				Ø9.52 (3/8) x 2

Notes :1. Capacities are based on the following conditions
 Heating: - Indoor Temperature 20°C(68°F) DB/15°C(59°F) WB
 - Outdoor Temperature 7°C(44.6°F) DB/6°C(42.8°F) WB
 Piping Length: - Interconnecting Piping Length 7.5m
 - Level Difference of Zero
 2. * : See page "Combination Table".
 3. Due to our policy of innovation some specifications may be changed without notification.
 4. At least two indoor units should be connected
 5. Minimum combination capacity rate should be more than 40%
 6. This product contains fluorinated greenhouse gases

OUTDOOR UNITS

A3UW21GFA2



LG participates in the ECP programme for EUROVENT AC program.
Check ongoing validity of certification
:www.eurovent-certification.com

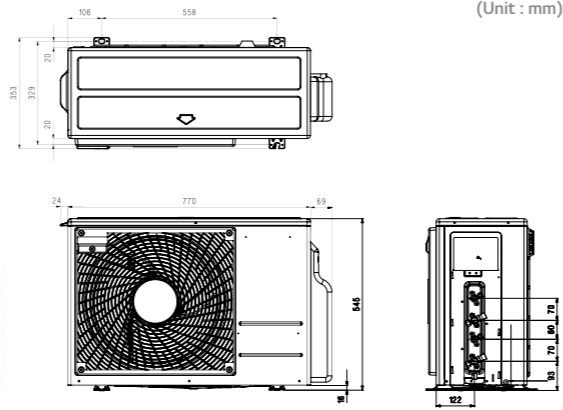

OUTDOOR UNIT				A3UW21GFA2
Compressor	Type			Twin Rotary
Capacity *	Cooling	Min / Nom / Max	kW	1.1 / 6.2 / 7.3
	Heating	Min / Nom / Max	kW	1.2 / 7.0 / 7.8
Low Temperature Capacity	Heating -7°C	Max	kW	4.9
Power Input *	Cooling	Min / Nom / Max	kW	0.3 / 1.6 / 2.2
	Heating	Min / Nom / Max	kW	0.3 / 1.7 / 2.4
Running Current	Cooling	Min / Nom / Max	A	1.2 / 7.2 / 10.0
	Heating	Min / Nom / Max	A	1.2 / 7.7 / 11.0
EER				4.00
COP				4.20
SEER				7.30
SCOP				4.21
Pdesign (@-10°C)				kW
Seasonal Energy Label	Cooling / Heating (A++ to E Scale)			A++ / A+
Annual Energy Consumption	Cooling / Heating			283 / 1,729
Airflow Rate	Nom			m ³ /min
Sound Pressure	Cooling	Nom		dBA
	Heating	Nom		dBA
Sound Power	Cooling	Max		dBA
Dimensions	W x H x D			mm
Net Weight				Kg
	Charge			Kg
	Additional Charge			g/m
	GWP			
Operation Range (Outdoor)	Cooling	Min - Max		°C DB
	Heating	Min - Max		°C WB
Power Supply				Ø / V / Hz
Power Supply Cable				No. x mm ²
Transmission Cable				No. x mm ²
Circuit Breaker				A
Piping Length Total				m
Piping Length per Branch	Max			m
	IDU - ODU	Max		m
Piping Elevation Difference	IDU - IDU	Max		m
				m
Piping Connection	Liquid			mm(inch) x No.
	Gas			mm(inch) x No.

Notes :1. Capacities are based on the following conditions
Heating: - Indoor Temperature 20°C(68°F) DB/15°C(59°F) WB
- Outdoor Temperature 7°C(44.6°F) DB/6°C(42.8°F) WB
Piping Length: - Interconnecting Piping Length 7.5m
- Level Difference of Zero

- * :See page "Combination Table".
- Due to our policy of innovation some specifications may be changed without notification.
- At least two indoor units should be connected
- Minimum combination capacity rate should be more than 40%
- This product contains fluorinated greenhouse gases

A5UW30GFA2



LG participates in the ECP programme for EUROVENT AC program.
Check ongoing validity of certification
:www.eurovent-certification.com

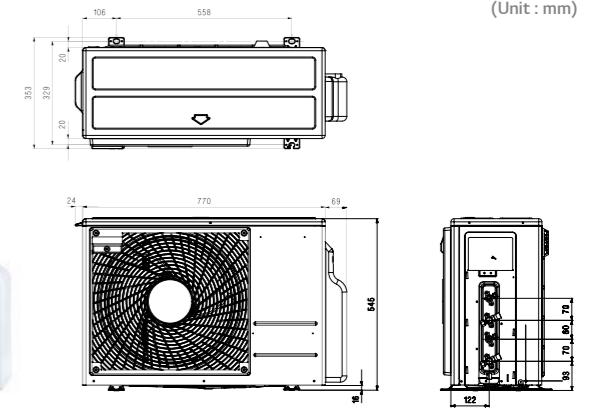

OUTDOOR UNIT				A5UW30GFA2
Compressor	Type			Twin Rotary
Capacity *	Cooling	Min / Nom / Max	kW	1.3 / 8.8 / 10.6
	Heating	Min / Nom / Max	kW	1.5 / 10.1 / 12.1
Low Temperature Capacity	Heating -7°C	Max	kW	7.1
Power Input *	Cooling	Min / Nom / Max	kW	0.4 / 2.3 / 3.6
	Heating	Min / Nom / Max	kW	0.6 / 2.3 / 3.7
Running Current	Cooling	Min / Nom / Max	A	1.9 / 10.2 / 16.2
	Heating	Min / Nom / Max	A	2.8 / 10.4 / 16.8
EER				3.90
COP				4.41
SEER				7.00
SCOP				4.00
Pdesign (@-10°C)				kW
Seasonal Energy Label	Cooling / Heating (A++ to E Scale)			A++ / A+
Annual Energy Consumption	Cooling / Heating			440 / 2,520
Airflow Rate	Nom			m ³ /min
Sound Pressure	Cooling	Nom		dBA
	Heating	Nom		dBA
Sound Power	Cooling	Max		dBA
Dimensions	W x H x D			mm
Net Weight				Kg
	Charge			Kg
	Additional Charge			g/m
	GWP			
Operation Range (Outdoor)	Cooling	Min - Max		°C DB
	Heating	Min - Max		°C WB
Power Supply				Ø / V / Hz
Power Supply Cable				No. x mm ²
Transmission Cable				No. x mm ²
Circuit Breaker				A
Piping Length Total				m
Piping Length per Branch	Max			m
	IDU - ODU	Max		m
Piping Elevation Difference	IDU - IDU	Max		m
				m
Piping Connection	Liquid			mm(inch) x No.
	Gas			mm(inch) x No.

Notes :1. Capacities are based on the following conditions
Heating: - Indoor Temperature 20°C(68°F) DB/15°C(59°F) WB
- Outdoor Temperature 7°C(44.6°F) DB/6°C(42.8°F) WB
Piping Length: - Interconnecting Piping Length 7.5m
- Level Difference of Zero

- * :See page "Combination Table".
- Due to our policy of innovation some specifications may be changed without notification.
- At least two indoor units should be connected
- Minimum combination capacity rate should be more than 40%
- This product contains fluorinated greenhouse gases

OUTDOOR UNITS

A5UW40GFA0



LG participates in the ECP programme for EUROVENT AC program.
Check ongoing validity of certification
:www.eurovent-certification.com

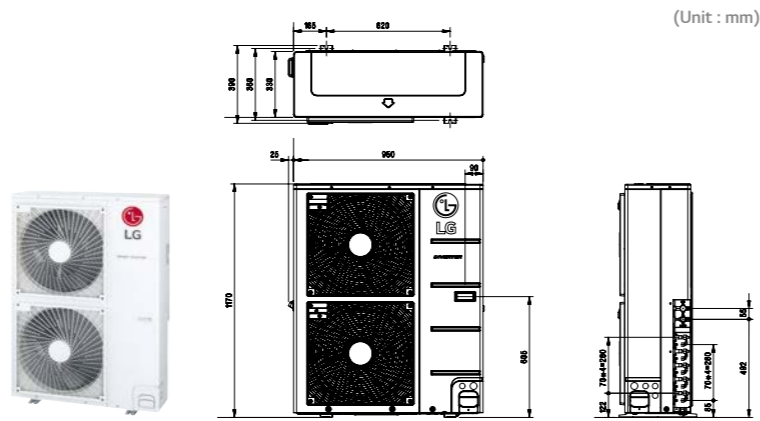

OUTDOOR				A5UW40GFA0				
Compressor	Type			Twin Rotary				
	Cooling	Min / Nom / Max	kW	0.9 / 11.2 / 13.5				
Capacity*	Heating	Min / Nom / Max	kW	1.0 / 12.5 / 15.0				
	Low Temperature Capacity	Heating -7°C	Max	11.0				
Power Input*	Cooling	Min / Nom / Max	kW	0.8 / 2.7 / 4.2				
	Heating	Min / Nom / Max	kW	0.8 / 2.8 / 4.5				
Running Current	Cooling	Min / Nom / Max	A	3.5 / 12.1 / 18.4				
	Heating	Min / Nom / Max	A	3.6 / 12.5 / 19.7				
EER				4.10				
COP				4.45				
SEER				5.80				
SCOP				3.81				
Pdesign (@ -10°C)				11.8				
Seasonal Energy Label	Cooling / Heating (A++ to E Scale)				A+ / A			
Annual Energy Consumption	Cooling / Heating				643 / 4,236			
Airflow Rate	Nom		m ³ /min		90			
Sound Pressure	Cooling	Nom		dBA		53		
	Heating	Nom		dBA		55		
Sound Power	Cooling	Max		dBA		67		
	Dimensions	W x H x D		mm		950 x 1,170 x 330		
Net Weight				kg		84.0		
	Charge			kg		3.8		
	Additional Charge			g/m		20		
	GWP					2,087.5		
	t-CO ₂ eq					7.9		
Operation Range (Outdoor)	Cooling	Min - Max	°C DB		-10 - 48			
	Heating	Min - Max	°C WB		-18 - 18			
Power Supply				Ø / V / Hz		1 / 220-240 / 50		
Power Supply Cable				No. x mm ²		3C x 3.5		
Transmission Cable				No. x mm ²		4C x 0.75		
Circuit Breaker				A		30		
Piping Length Total				m		85		
				m		25		
	Piping Elevation Difference	IDU - ODU	Max	m		15		
		IDU - IDU	Max	m		7.5		
Piping Connection	Liquid			mm (inch) x No.		Ø6.35 (1/4) x 5		
	Gas			mm (inch) x No.		Ø9.52 (3/8) x 5		

Note : 1. Capacities are based on the following conditions:

Cooling : - Indoor Temperature 27°C (80.6°F) DB / 19°C (66.2°F) WB - Outdoor Temperature 35°C (95°F) DB / 24°C (75.2°F) WB
Heating : - Indoor Temperature 20°C (68°F) DB / 15°C (59°F) WB - Outdoor Temperature 7°C (44.6°F) DB / 6°C (42.8°F) WB
Piping Length - Interconnecting Piping Length 7.5m - Level Difference of Zero.

2. * :See page "Combination Table".

3. Due to our policy of innovation some specifications may be changed without notification.

4. At least two indoor units should be connected.

5. Minimum combination capacity rate should be more than 40%.

6. This product contains fluorinated greenhouse gases

A7UW40GFA0



LG participates in the ECP programme for EUROVENT AC program.
Check ongoing validity of certification
:www.eurovent-certification.com

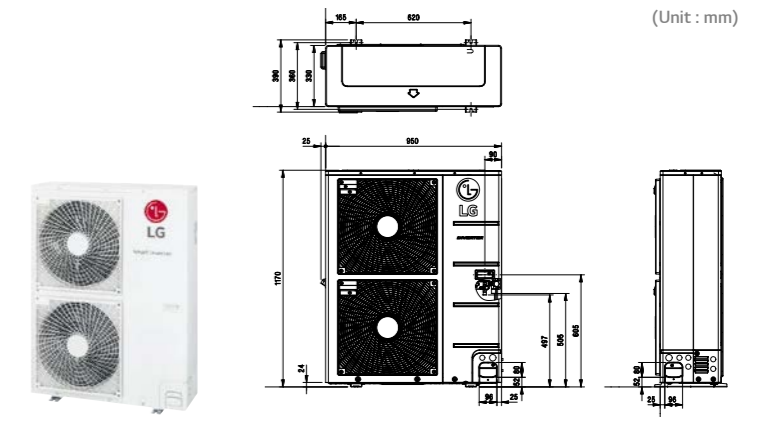

OUTDOOR				A7UW40GFA0				
Compressor	Type			Twin Rotary				
	Cooling	Min / Nom / Max	kW	2.8 / 11.2 / 13.5				
Capacity*	Heating	Min / Nom / Max	kW	3.1 / 12.5 / 15.0				
	Low Temperature Capacity	Heating -7°C	Max	11.0				
Power Input*	Cooling	Min / Nom / Max	kW	0.8 / 2.7 / 4.2				
	Heating	Min / Nom / Max	kW	0.8 / 2.8 / 4.5				
Running Current	Cooling	Min / Nom / Max	A	3.5 / 12.1 / 18.4				
	Heating	Min / Nom / Max	A	3.6 / 12.5 / 19.7				
EER				4.10				
COP				4.45				
SEER				5.60				
SCOP				3.81				
Pdesign (@ -10°C)				11.8				
Seasonal Energy Label	Cooling / Heating (A++ to E Scale)				A+ / A			
Annual Energy Consumption	Cooling / Heating				643 / 4,236			
Airflow Rate	Nom		m ³ /min		90			
Sound Pressure	Cooling	Nom		dBA		53		
	Heating	Nom		dBA		55		
Sound Power	Cooling	Max		dBA		67		
	Dimensions	W x H x D		mm		950 x 1,170 x 330		
Net Weight				kg		82.0		
	Charge			kg		3.8		
	Additional Charge			g/m		20		
	GWP					2,087.5		
	t-CO ₂ eq					7.9		
Operation Range (Outdoor)	Cooling	Min - Max	°C DB		-10 - 48			
	Heating	Min - Max	°C WB		-18 - 18			
Power Supply				Ø / V / Hz		1 / 220-240 / 50		
Power Supply Cable				No. x mm ²		3C x 3.5		
Transmission Cable				No. x mm ²		4C x 1.25		
Circuit Breaker				A		30		
				m		100		
Max Piping Length				m		50		
				m		50		
				m		15		
				m		15		
Piping Elevation Difference	IDU - ODU	Max	m		30			
	IDU - IDU	Max	m		15			
Piping Connection	Liquid			mm (inch)		Ø9.52 (3/8)		
	Gas			mm (inch)		Ø19.05 (3/4)		

Note : 1. Capacities are based on the following conditions:

Cooling : - Indoor Temperature 27°C (80.6°F) DB / 19°C (66.2°F) WB - Outdoor Temperature 35°C (95°F) DB / 24°C (75.2°F) WB
Heating : - Indoor Temperature 20°C (68°F) DB / 15°C (59°F) WB - Outdoor Temperature 7°C (44.6°F) DB / 6°C (42.8°F) WB
Piping Length - Interconnecting Piping Length 7.5m - Level Difference of Zero.

2. * :See page "Combination Table".

3. Due to our policy of innovation some specifications may be changed without notification.

4. At least two indoor units should be connected.

5. Minimum combination capacity rate should be more than 40%.

6. This product contains fluorinated greenhouse gases

OUTDOOR UNITS

A8UW48GFAO

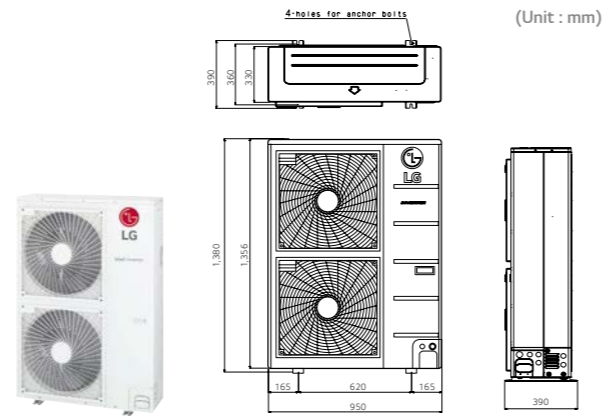

A9UW56GFAO

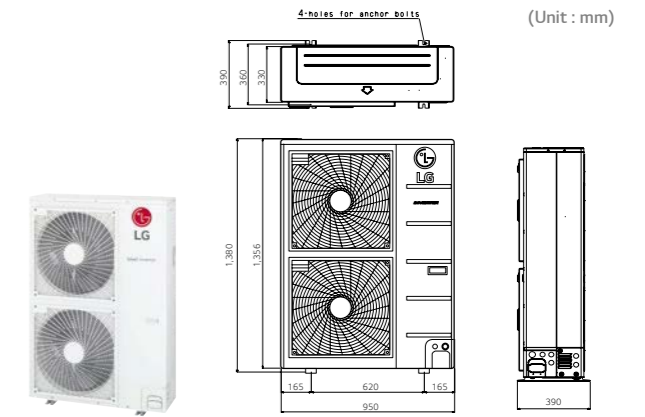

OUTDOOR				A8UW48GFAO	
Compressor	Type			Twin Rotary	
	Capacity*	Cooling	Min / Nom / Max	kW	3.3 / 14.0 / 17.0
Capacity*	Heating	Min / Nom / Max	kW	3.7 / 16.0 / 17.3	
	Low Temperature Capacity	Heating -7°C	Max	kW	14.8
Power Input*	Cooling	Min / Nom / Max	kW	0.8 / 3.2 / 5.1	
	Heating	Min / Nom / Max	kW	1.3 / 3.7 / 5.2	
Running Current	Cooling	Min / Nom / Max	A	3.9 / 13.2 / 22.3	
	Heating	Min / Nom / Max	A	6.9 / 15.6 / 22.7	
EER				4.41	
COP				4.37	
SEER				6.1	
SCOP				4.0	
Pdesign (@ -10°C)				kW	11.7
Seasonal Energy Label	Cooling / Heating (A++ to E Scale)			-	
Annual Energy Consumption	Cooling / Heating			kWh	1,377 / 4,095
	Airflow Rate	Nom	m ³ /min	120	
Sound Pressure	Cooling	Nom	dBA	54	
	Heating	Nom	dBA	56	
Sound Power	Cooling / Heating	Max	dBA	68 / 71	
	Dimensions	W x H x D	mm	950 x 1,380 x 330	
Net Weight				kg	96.0
	Charge			kg	4.4
	Additional Charge			g/m	20
	GWP				2,087.5
	t-CO ₂ eq				9.2
Operation Range (Outdoor)	Cooling	Min - Max	°C DB	-10 - 48	
	Heating	Min - Max	°C WB	-18 - 18	
Power Supply				Ø / V / Hz	1 / 220-240 / 50
Power Supply Cable				No. x mm ²	3C x 4.0
Transmission Cable	ODU-BD			No. x mm ²	4C x 1.25
	BD-IDU			No. x mm ²	4C x 0.75
Circuit Breaker				A	40
Max Piping Length	Total Piping (Main + Total Branch)		m	135	
	Main Piping		m	55	
	Total Branch Piping		m	80	
	Each Branch Piping		m	15	
Piping Elevation Difference	IDU - ODU	Max	m	30	
	IDU - IDU	Max	m	15	
Piping Connection	Liquid			mm (inch)	Ø9.52 (3/8)
	Gas			mm (inch)	Ø19.05 (3/4)

OUTDOOR				A9UW56GFAO	
Compressor	Type			Twin Rotary	
	Capacity*	Cooling	Min / Nom / Max	kW	4.0 / 15.5 / 18.5
Capacity*	Heating	Min / Nom / Max	kW	4.5 / 17.4 / 18.8	
	Low Temperature Capacity	Heating -7°C	Max	kW	16.1
Power Input*	Cooling	Min / Nom / Max	kW	1.0 / 3.9 / 5.9	
	Heating	Min / Nom / Max	kW	1.5 / 4.2 / 6.2	
Running Current	Cooling	Min / Nom / Max	A	4.6 / 16.1 / 25.7	
	Heating	Min / Nom / Max	A	7.4 / 16.8 / 27.2	
EER				4.01	
COP				4.18	
SEER				5.6	
SCOP				4.0	
Pdesign (@ -10°C)				kW	12.3
Seasonal Energy Label	Cooling / Heating (A++ to E Scale)			-	
Annual Energy Consumption	Cooling / Heating			kWh	1,661 / 4,305
	Airflow Rate	Nom	m ³ /min	120	
Sound Pressure	Cooling	Nom	dBA	54	
	Heating	Nom	dBA	56	
Sound Power	Cooling / Heating	Max	dBA	69 / 73	
	Dimensions	W x H x D	mm	950 x 1,380 x 330	
Net Weight				kg	96.0
	Charge			kg	4.4
	Additional Charge			g/m	20
	GWP				2,087.5
	t-CO ₂ eq				9.2
Operation Range (Outdoor)	Cooling	Min - Max	°C DB	-10 - 48	
	Heating	Min - Max	°C WB	-18 - 18	
Power Supply				Ø / V / Hz	1 / 220-240 / 50
Power Supply Cable				No. x mm ²	3C x 4.0
Transmission Cable	ODU-BD			No. x mm ²	4C x 1.25
	BD-IDU			No. x mm ²	4C x 0.75
Circuit Breaker				A	40
Max Piping Length	Total Piping (Main + Total Branch)		m	145	
	Main Piping		m	55	
	Total Branch Piping		m	90	
	Each Branch Piping		m	15	
Piping Elevation Difference	IDU - ODU	Max	m	30	
	IDU - IDU	Max	m	15	
Piping Connection	Liquid			mm (inch)	Ø9.52 (3/8)
	Gas			mm (inch)	Ø19.05 (3/4)

Note : 1. Capacities are based on the following conditions:
 Cooling : - Indoor Temperature 27°C (80.6°F) DB / 19°C (66.2°F) WB - Outdoor Temperature 35°C (95°F) DB / 24°C (75.2°F) WB
 Heating : - Indoor Temperature 20°C (68°F) DB / 15°C (59°F) WB - Outdoor Temperature 7°C (44.6°F) DB / 6°C (42.8°F) WB
 Piping Length - Interconnecting Piping Length 7.5m - Level Difference of Zero.
 2. * : See page "Combination Table".
 3. Due to our policy of innovation some specifications may be changed without notification.
 4. At least two indoor units should be connected.
 5. Minimum combination capacity rate should be more than 40%.
 6. This product contains fluorinated greenhouse gases

Note : 1. Capacities are based on the following conditions:
 Cooling : - Indoor Temperature 27°C (80.6°F) DB / 19°C (66.2°F) WB - Outdoor Temperature 35°C (95°F) DB / 24°C (75.2°F) WB
 Heating : - Indoor Temperature 20°C (68°F) DB / 15°C (59°F) WB - Outdoor Temperature 7°C (44.6°F) DB / 6°C (42.8°F) WB
 Piping Length - Interconnecting Piping Length 7.5m - Level Difference of Zero.
 2. * : See page "Combination Table".
 3. Due to our policy of innovation some specifications may be changed without notification.
 4. At least two indoor units should be connected.
 5. Minimum combination capacity rate should be more than 40%.
 6. This product contains fluorinated greenhouse gases

WALL MOUNTED UNITS

Wi-Fi Control (ARTCOOL)

Control your air conditioners via using the smart internet devices as Android or iOS based smartphones. This advanced technology provides you the best convenience.

• LG Smart ThinQ



Search "LG Smart ThinQ" on Google market or Appstore then download the app.



LG Smart ThinQ

• How it Works

Easy Registration and Log-in

Follow the easy set-up steps that will activate SmartThinQ's impressive feature.

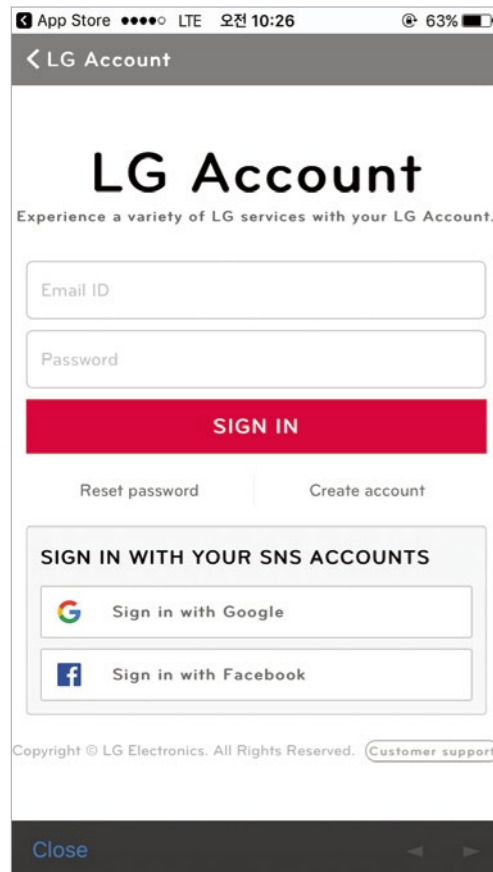

• Wi-Fi Connectivity

Let's every member of your family choose their own preferred air conditioning temperature and fan speed, then save the settings in their app to run later. You can save the setting for each air conditioner as well.

Multiple Devices



Multi-Control



* Can be controlled by multiple users, but not simultaneously

Aesthetic Design

You no longer need to be told what your air conditioner should look like. With LG's revolutionary ARTCOOL Gallery, you can change the look of your air conditioner to whatever you want, whenever you want. The ARTCOOL series have outstanding designs and have been awarded the International Forum Design Award, the Reddot Design Award and the G Mark.

• ARTCOOL



• Standard



WALL MOUNTED UNITS

Plasmaster™ Ionizer^{PLUS} (ARTCOOL)

The powerful plasma ionizer protects you from odors and harmful substances in the air with over 3 million ions to sterilize not only the air passing through the air conditioner, but also surrounding surfaces for a safer, cleaner environment.

* Specifications may vary for each model.
 * Depending on the experimental conditions.
 * This function will be available with following models and date.
 - ARNU**GSJN4, ARNU**GSKN4 : From '17 May

• How It Works

Sterilization and Deodorization (Utilizes Over 3 Million Ions)

Plasmaster Ionizer+ reduces harmful microscopic particles by infusing the air passing through the air conditioner with over 3 millions ions.

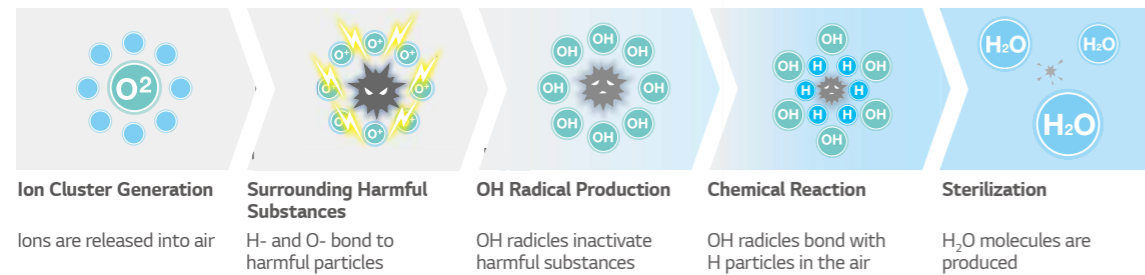

• Test Result

Sterilization Performance Evaluations

Plasmaster Ionizer+ reduces harmful microscopic particles by infusing the air passing through the air conditioner with over 3 millions ions.

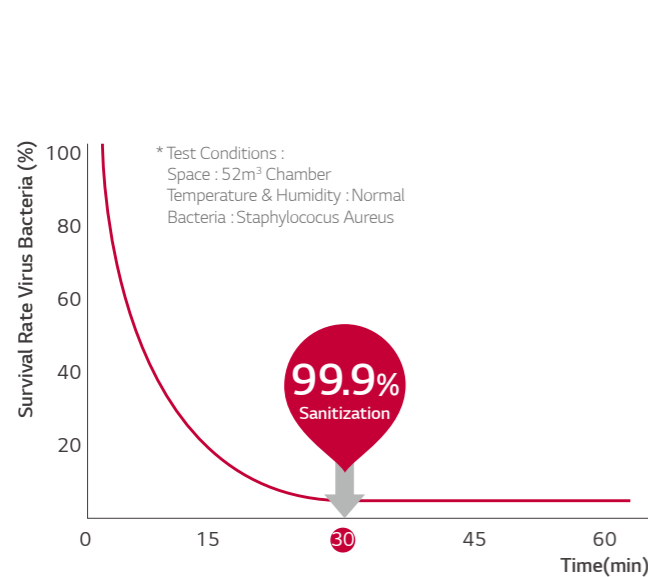

2.1 odor strength decrease in 60 minutes

An odor of strength 2 or less indicates that there is odor but no sense of displeasure (degree of odor permissible).

Odor Strength	1	2	3	4
Offensive odor substance sensitivity	Mountain smell	Indoor life smell	Bathroom smell	Food waste smell
Odor strength level	Light	Moderate	Strong	Very Strong

Odor strength reduce 3.6 → 1.5 / The Odor floating in the room as well as curtain and clothes.

Quick & Easy Installation

LG air conditioner is designed for an easy and efficient installation, making possible to install several units in a short period of time

* Specifications may vary for each model.

• Concept

By reducing the manpower and time required for installation, it is now possible to install more units in less time.

• How It Works

One Simple Packing Box

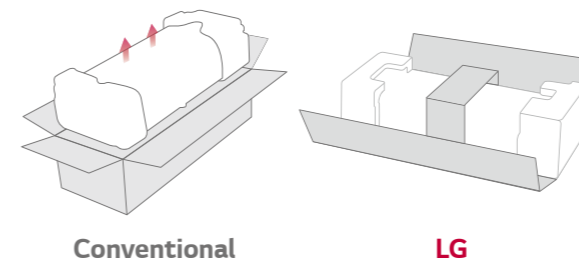

Installation Plate Improvement

LG's installation plate is larger and customized to reduce installation time.

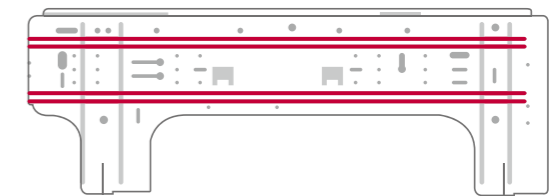

Installation Support Clip

A support clip creates adequate space between the wall and the unit for easier installation.

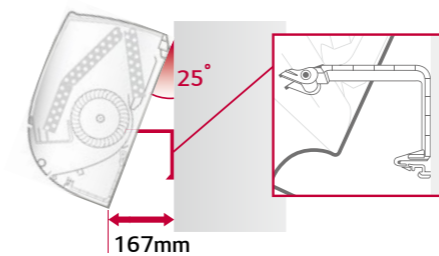

Wider Tubing Space

The space provided for tubing facilitates the whole installation process and hides the unorganized parts, making it appear clean and tidy.

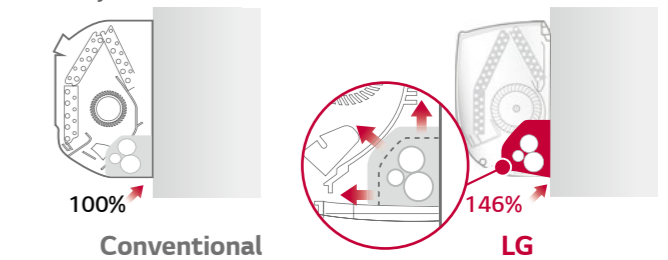

Detachable Bottom Cover

The air conditioner's bottom cover is detachable for easier installation and access.

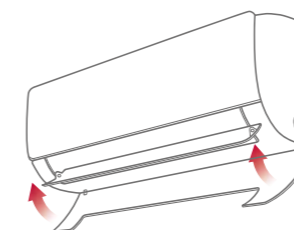

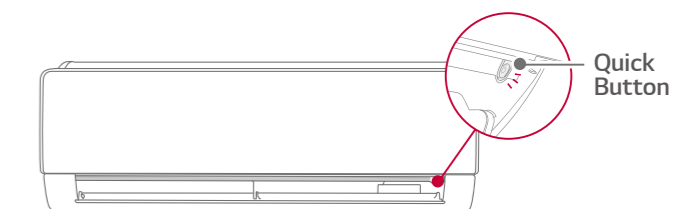

Quick button for running test

The test button is conveniently located and easy to find.



WALL MOUNTED UNITS

		kBtu/h	7	9	12	18	24
		kW	2.1	2.6	3.5	5.3	7.0
Wall Mounted Unit	ARTCOOL		AMNW07GSJR0	AMNW09GSJR0	AMNW12GSJR0	AMNW18GSKR0	AMNW24GSKR0

		kBtu/h	7	9	12	18	24
		kW	2.1	2.6	3.5	5.3	7.0
Wall Mounted Unit	Standard		AMNW07GSJA0	AMNW09GSJA0	AMNW12GSJA0	AMNW18GSKA0	AMNW24GSKA0

ARTCOOL

				AMNW07GSJR0	AMNW09GSJR0	AMNW12GSJR0	AMNW18GSKR0	AMNW24GSKR0
Capacity	Cooling / Heating	Nom	kW	2.1 / 2.3	2.5 / 3.2	3.5 / 3.8	5.0 / 5.8	6.6 / 7.5
Power Input		Nom	W	17	18	19	39	45
Running Current		Nom	A	0.14	0.16	0.17	0.28	0.33
Power Supply			Ø / V / Hz	1 / 220-240 / 50	1 / 220-240 / 50	1 / 220-240 / 50	1 / 220-240 / 50	1 / 220-240 / 50
Air Flow Rate		H / M / L	m ³ /min	8.6 / 7.2 / 5.6	9.2 / 7.4 / 5.6	9.6 / 8.1 / 5.6	14.2 / 11.3 / 9.9	15.2 / 12.7 / 10.2
Sound Pressure		H / M / L	dB(A)	35 / 32 / 27	36 / 33 / 27	40 / 35 / 27	44 / 38 / 35	46 / 41 / 36
Sound Power			dB(A)	57	57	57	59	65
Dehumidification Rate			l/h	0.9	1.1	1.2	1.9	2.6
Dimension		W x H x D	mm	837 x 308 x 192	837 x 308 x 192	837 x 308 x 192	998 x 345 x 212	998 x 345 x 212
Net weight			kg	9.1	9.9	9.9	13.2	11.6
Piping Connection	Liquid		mm (inch)	Ø 6.35 (1/4)	Ø 6.35 (1/4)	Ø 6.35 (1/4)	Ø 6.35 (1/4)	Ø 6.35 (1/4)
	Gas		mm (inch)	Ø 9.52 (3/8)	Ø 9.52 (3/8)	Ø 9.52 (3/8)	Ø 12.7 (1/2)	Ø 12.7 (1/2)

STANDARD

				AMNW07GSJA0	AMNW09GSJA0	AMNW12GSJA0	AMNW18GSKA0	AMNW24GSKA0
Capacity	Cooling / Heating	Nom	kW	2.1 / 2.3	2.5 / 3.2	3.5 / 3.8	5.0 / 5.8	6.6 / 7.5
Power Input		Nom	W	17	18	19	39	45
Running Current		Nom	A	0.14	0.16	0.17	0.28	0.33
Power Supply			Ø / V / Hz	1 / 220-240 / 50	1 / 220-240 / 50	1 / 220-240 / 50	1 / 220-240 / 50	1 / 220-240 / 50
Air Flow Rate		H / M / L	m ³ /min	8.6 / 7.2 / 5.6	9.2 / 7.4 / 5.6	9.6 / 8.1 / 5.6	14.2 / 11.3 / 9.9	15.2 / 12.7 / 10.2
Sound Pressure		H / M / L	dB(A)	35 / 32 / 27	36 / 33 / 27	40 / 35 / 27	44 / 38 / 35	46 / 41 / 36
Sound Power			dB(A)	57	57	57	59	65
Dehumidification Rate			l/h	0.9	1.1	1.2	1.9	2.6
Dimension		W x H x D	mm	837 x 308 x 189	837 x 308 x 189	837 x 308 x 189	998 x 345 x 210	998 x 345 x 210
Net weight			kg	8.7	8.7	8.7	12.0	12.8
Piping Connection	Liquid		mm (inch)	Ø 6.35 (1/4)	Ø 6.35 (1/4)	Ø 6.35 (1/4)	Ø 6.35 (1/4)	Ø 6.35 (1/4)
	Gas		mm (inch)	Ø 9.52 (3/8)	Ø 9.52 (3/8)	Ø 9.52 (3/8)	Ø 12.7 (1/2)	Ø 12.7 (1/2)

CEILING MOUNTED CASSETTE (1WAY)

6-Step Vane Control

There are 6 different steps to control air flow direction. Also 1 way cassette has vane to move auto swing between left and right as 120 degree.

Moving Air Flow 1 Way cassette

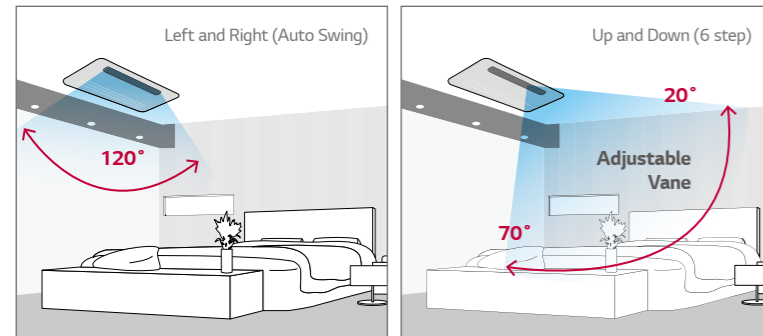

Fixed Air Flow Duct system

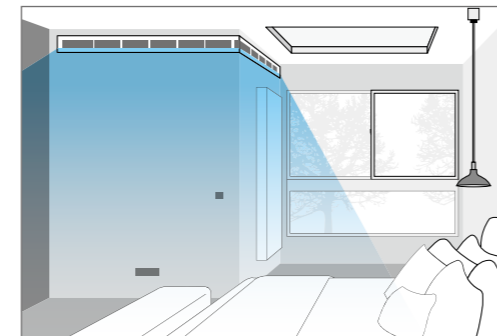

Minimized Height

LG 1 Way cassette isn't affected by installation environment. LG 1 Way cassette height is 132mm and duct is 190mm, so it can provide ideal solution for installation in limited space.

Size Comparison

	LG	A Company	B Company
1 Way Cassette	132	215	230
Duct	190	200	200

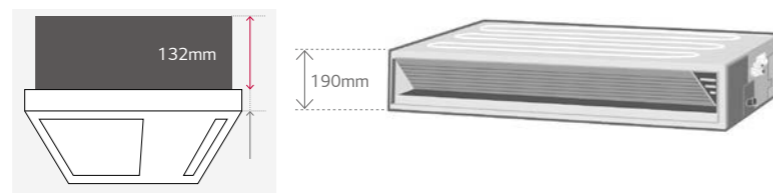

Flexible Installation

The access for inspection at 1 Way Cassette does not require additional ducted space making the installation environment uncomplicated.

1 Way cassette

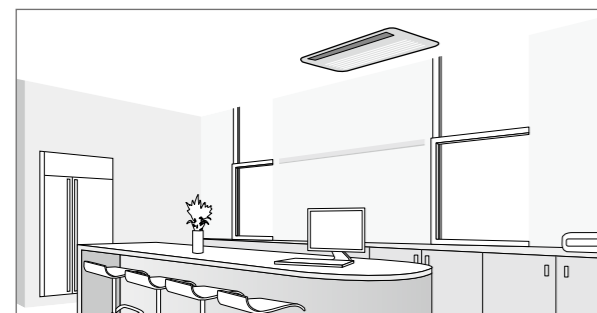

Duct

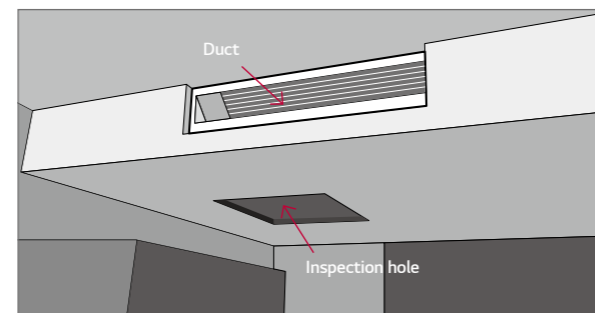

CAPACITY (kW)		2.6	3.5
1 Way Cassette		AMNW09GTUC0	AMNW12GTUC0

INDOOR				AMNH09GTUC0	AMNH12GTUC0
Capacity	Cooling / Heating	Nom	kW	2.6 / 2.9	3.5 / 3.9
Power Input		Nom	W	20	20
Running Current		Nom	A	0.2	0.2
Power Supply			Ø / V / Hz	1 / 220-240 / 50	1 / 220-240 / 50
Air Flow Rate		H / M / L	m³/min	7.5 / 7.3 / 6.8	8.1 / 7.4 / 7.0
Sound Pressure	Cooling	H / M / L	dBA	36 / 34 / 32	37 / 36 / 33
Sound Power	Cooling	Max	dBA	54	57
Dehumidification Rate			l/h	1.1	1.2
Dimensions	Body	W x H x D	mm	860 x 132 x 450	860 x 132 x 450
Net Weight	Body		kg	13.5	13.5
Piping Connection	Liquid		mm (inch)	Ø6.35 (1/4)	Ø6.35 (1/4)
	Gas		mm (inch)	Ø9.52 (3/8)	Ø9.52 (3/8)
Decoration Panel	Model			PT-UUC1	PT-UUC1
	Color			Morning Fog (RAL120-4)	Morning Fog (RAL120-4)
	Dimensions	W x H x D	mm	1,100 x 34 x 500	1,100 x 34 x 500
	Weight		kg	4.4	4.4

* CT09, CT12, CT18, CT24 are compatible between SCAC and MULTI.

CEILING MOUNTED CASSETTE (4WAY)

950/700 Panel – Wide Jet Air Flow

Improved vanes reduce the curved area and provide even distribution.

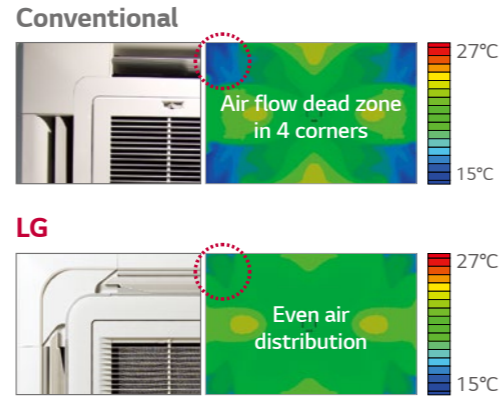
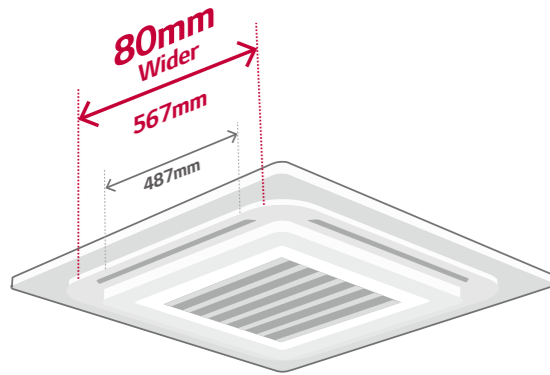

620 Panel – Compact and Stylish Design

- New 4 way cassette panel adapted unibody shape and matching with into the ceiling
- Panel size is fit into the ceiling tile

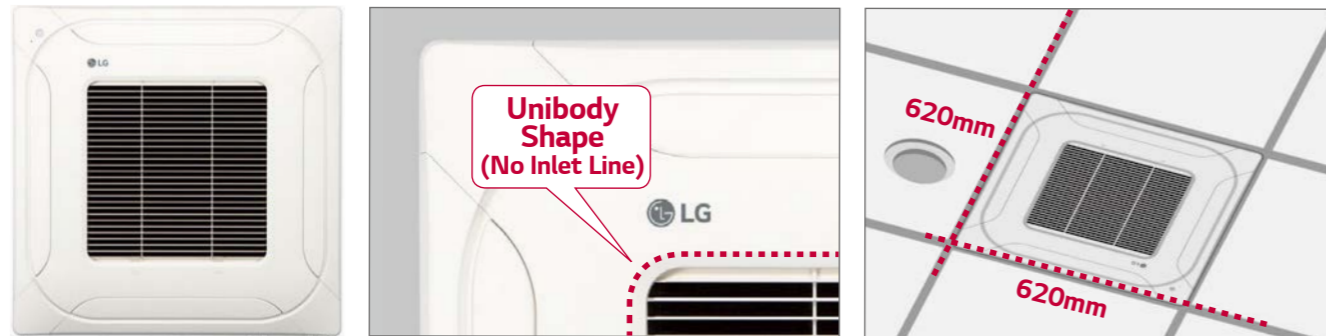

Convenient Panel Installation

The detachable corner design makes it easy to adjust the hanger during installation and to check for leakages in the drain connection pipe.

Detachable Corner Design

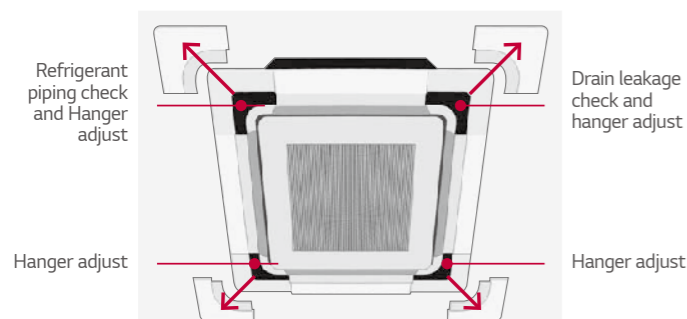

Drain Leakage Check Hanger Adjust

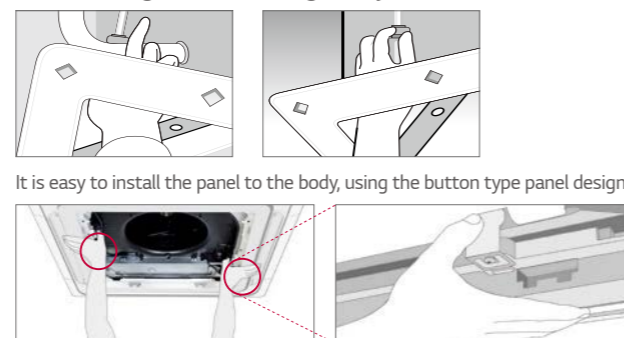

		CAPACITY (KW)		2.6	3.5	5.3	7.0
4 Way Cassette				AMNW09GTRA1	AMNW12GTRA1	AMNW18GTQA1	AMNW24GTPA1

INDOOR				AMNW09GTRA1	AMNW12GTRA1	AMNW18GTQA1	AMNW24GTPA1
Capacity	Cooling / Heating	Nom	kW	2.6 / 2.9	3.5 / 3.9	5.3 / 5.8	6.7 / 7.5
Power Input		Nom	W	20	20	20	20
Running Current		Nom	A	0.4	0.4	0.4	0.6
Power Supply			Ø / V / Hz	1 / 220-240 / 50	1 / 220-240 / 50	1 / 220-240 / 50	1 / 220-240 / 50
Air Flow Rate		H / M / L	m ³ /min	8.5 / 7.0 / 6.0	9.5 / 8.0 / 7.0	13.0 / 12.0 / 11.0	17.0 / 15.0 / 13.0
Sound Pressure	Cooling	H / M / L	dB(A)	36 / 33 / 30	38 / 35 / 32	41 / 39 / 36	38 / 36 / 34
Sound Power	Cooling	Max	dB(A)	48	51	55	57
Dehumidification Rate			l/h	1.4	1.7	2.1	2.4
Dimensions	Body	W x H x D	mm	570 x 214 x 570	570 x 214 x 570	570 x 256 x 570	840 x 204 x 840
Net Weight	Body		kg	14.0	14.0	15.5	20.5
Piping Connection	Liquid		mm (inch)	Ø6.35 (1/4)	Ø6.35 (1/4)	Ø6.35 (1/4)	Ø6.35 (1/4)
	Gas		mm (inch)	Ø9.52 (3/8)	Ø9.52 (3/8)	Ø12.7 (1/2)	Ø12.7 (1/2)
Decoration Panel	Model				PT-UQC, PT-QCHW0		PT-UMC1
	Color				Morning Fog (RAL 120-4)		Morning Fog (120-4)
	Dimensions	W x H x D	mm		700 x 22 x 700, 620 x 20 x 620		950 x 25 x 950
	Weight		kg		3.0		5.0

Note : 1. Capacities are based on the following conditions :
 Cooling : - Indoor Temperature 27°C (80.6°F) DB / 19°C (66.2°F) WB - Outdoor Temperature 35°C (95°F) DB / 24°C (75.2°F) WB
 Heating : - Indoor Temperature 20°C (68°F) DB / 15°C (59°F) WB - Outdoor Temperature 7°C (44.6°F) DB / 6°C (42.8°F) WB
 Piping Length - Interconnecting Piping Length 7.5m - Level Difference of Zero
 2. Definition of Power Input Nominal conditions - Performance tested under EN14511
 3. Due to our policy of innovation some specifications may be changed without notification
 4. This product contains fluorinated greenhouse gases

CEILING CONCEALED DUCT

E.S.P. (External Static Pressure) Control

E.S.P. control function can make air volume controlled easily with remote controller. The BLDC motor can control fan speed and air volume regardless of the external static pressure. No additional accessories are necessary to control air flow.

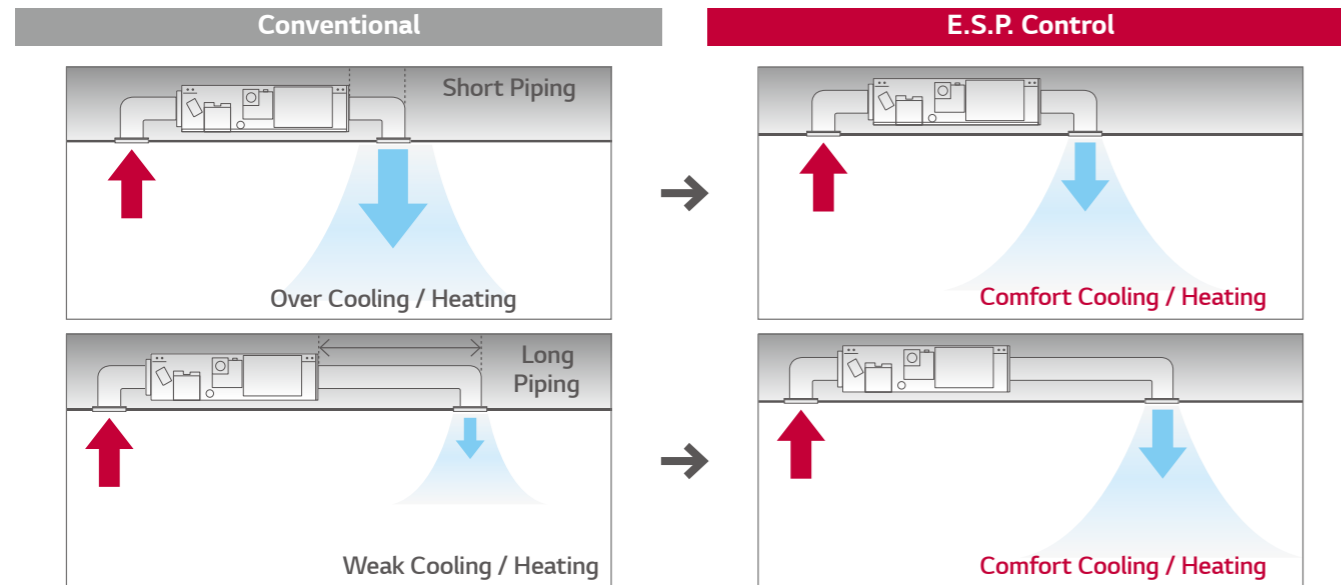

Easy Service & Maintenance

Users don't need to open whole panel for maintenance, since panel is divided into one for heat exchanger and one for fan/motor. Easily detach and attach the filter even in limited space.

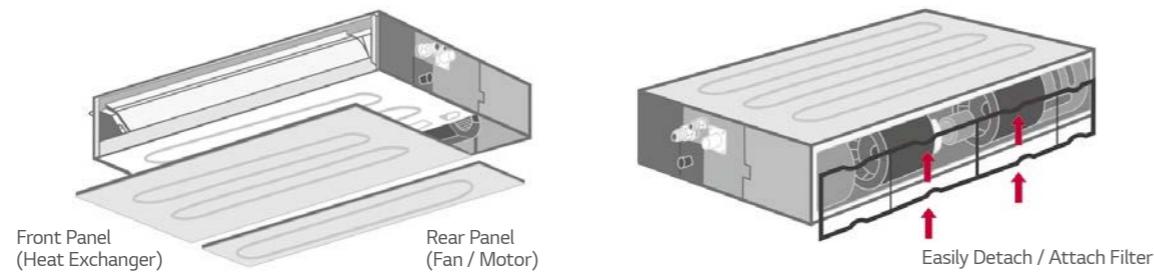

Flexible Installation

The new low static duct allows the air intake at the rear or bottom under installation condition.

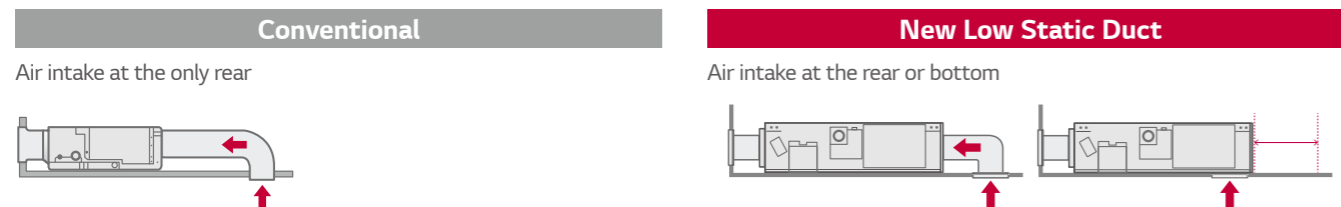

		CAPACITY (kW)	2.6	3.5	5.3	7.0
Ceiling Concealed Duct			AMNW09GL1A2	AMNW12GL2A2	AMNW18GL2A2	MNW24GL3A2
			-	-	AMNW18GM1A0	AMNW24GM1A0

INDOOR			AMNW09GL1A2	AMNW12GL2A2	AMNW18GL2A2	AMNW24GL3A2
Capacity	Cooling / Heating	Nom kW	2.6 / 2.9	3.5 / 3.9	5.3 / 5.8	7.0 / 7.7
Power Input		Min / Max (Nom ESP)	40 / 60	80 / 100	100 / 140	110 / 160
		W				
Running Current		Nom A	0.4	0.8	0.8	1.0
Power Supply		Ø / V / Hz	1 / 220-240 / 50	1 / 220-240 / 50	1 / 220-240 / 50	1 / 220-240 / 50
Air Flow Rate		H / M / L m ³ /min	9.0 / 7.0 / 5.5	10.0 / 8.5 / 7.0	15.0 / 12.5 / 10.0	20.0 / 16.0 / 12.0
Sound Pressure	Cooling	H / M / L dBA	30 / 26 / 23	31 / 28 / 27	36 / 34 / 31	39 / 35 / 32
Sound Power	Cooling	Max dBA	49	52	54	58
Dehumidification Rate		l/h	1.1	1.2	1.7	2.2
Dimensions	Body	W x H x D mm	700 x 190 x 700	900 x 190 x 700	900 x 190 x 700	1,100 x 190 x 700
Net Weight	Body	kg	17.5	23.0	23.0	27.0
Piping Connection	Liquid	mm (inch)	Ø6.35 (1/4)	Ø6.35 (1/4)	Ø6.35 (1/4)	Ø9.52 (3/8)
	Gas	mm (inch)	Ø9.52 (3/8)	Ø9.52 (3/8)	Ø12.7 (1/2)	Ø15.88 (5/8)
External Static Pressure		Min - Max mmAq (Pa)	0 - 5 (0 - 49)	0 - 5 (0 - 49)	0 - 5 (0 - 49)	0 - 5 (0 - 49)

INDOOR			AMNW18GM1A0	AMNW24GM1A0
Capacity	Cooling / Heating	Nom kW	5.3 / 5.8	7.0 / 7.7
Power Input		Min / Max (Nom ESP)	90 / 160	100 / 180
		W		
Running Current		Nom A	0.9	1.0
Power Supply		Ø / V / Hz	1 / 220-240 / 50	1 / 220-240 / 50
Air Flow Rate		H / M / L m ³ /min	16.5 / 14.5 / 13.0	18.0 / 16.5 / 14.5
Sound Pressure	Cooling	H / M / L dBA	34 / 32 / 30	35 / 34 / 32
Sound Power	Cooling	Max dBA	59	60
Dehumidification Rate		l/h	2.0	2.5
Dimensions	Body	W x H x D mm	900 x 270 x 700	900 x 270 x 700
Net Weight	Body	kg	23.8	24.2
Piping Connection	Liquid	mm (inch)	Ø6.35 (1/4)	Ø6.35 (1/4)
	Gas	mm (inch)	Ø12.7 (1/2)	Ø12.7 (1/2)
External Static Pressure		Min - Max mmAq (Pa)	2.5-15 (25-147)	2.5-15 (25-147)

Note : 1. Capacities are based on the following conditions :
 Cooling : - Indoor Temperature 27°C (80.6°F) DB / 19°C (66.2°F) WB - Outdoor Temperature 35°C (95°F) DB / 24°C (75.2°F) WB
 Heating : - Indoor Temperature 20°C (68°F) DB / 15°C (59°F) WB - Outdoor Temperature 7°C (44.6°F) DB / 6°C (42.8°F) WB
 Piping Length - Interconnecting Piping Length 7.5m - Level Difference of Zero
 2. Definition of Power Input Nominal conditions - Performance tested under EN14511
 3. Due to our policy of innovation some specifications may be changed without notification
 4. This product contains fluorinated greenhouse gases

ACCESSORIES

Distributor Box

PMBD3620, PMBD3630, PMBD3640

Easy installation using the range of Distributor Boxes.

For	2 Indoors	3 Indoors	4 Indoors
Distributor	 PMBD3620	 PMBD3630	 PMBD3640

Various distributors can make much easier installation for any sites

Features

- Distribution of refrigerant to various indoor units.
- 3 models (2, 3, 4 Indoor Units)
- EEV included
- Controlling PCB inside the unit
- Internally insulated (Prevents any chances of drainage)
- Flare joints for easy and clean installation
- Compact design (Low height)
- Flexible installation



Specification

		PMBD3620	PMBD3630	PMBD3640
Connectable Indoor Units	Number of Indoor Units	1 - 2	1 - 3	1 - 4
	Capacity	5k / 7k / 9k / 12k / 18k / 24k	5k / 7k / 9k / 12k / 18k / 24k	5k / 7k / 9k / 12k / 18k / 24k
Power Source	Ø / V / Hz	1 / 220-240 / 50	1 / 200-240 / 50	1 / 200-240 / 50
Power Consumption	W	10	10	10
Running Current	A	0.05	0.05	0.05
Dimensions	W x H x D	mm (inch) 302 x 143 x 252 (11.9 x 5.6 x 9.9)	mm (inch) 302 x 143 x 252 (11.9 x 5.6 x 9.9)	mm (inch) 302 x 143 x 252 (11.9 x 5.6 x 9.9)
Net Weight	kg/lb	4.8 / 10.6	4.9 / 10.8	5 / 11
Piping Connection (To Outdoor Unit)	Liquid	mm (inch) Ø9.52 (3/8)	mm (inch) Ø9.52 (3/8)	mm (inch) Ø9.52 (3/8)
	Gas	mm (inch) Ø19.05 (3/4)	mm (inch) Ø19.05 (3/4)	mm (inch) Ø19.05 (3/4)
Piping Connection (To Indoor Unit)	Liquid	mm (inch) Ø6.35 (1/4) x 2EA	mm (inch) Ø6.35 (1/4) x 3EA	mm (inch) Ø6.35 (1/4) x 4EA
	Gas	mm (inch) Ø9.52 (3/8) x 2EA	mm (inch) Ø9.52 (3/8) x 3EA	mm (inch) Ø9.52 (3/8) x 4EA
Accessories	Hanger (Bracket)	EA 4	EA 4	EA 4
	Screw	EA 8	EA 8	EA 8
	Manual	EA 1	EA 1	EA 1

Note :
1. The piping connection must be suit the piping sizes of the indoor unit which will be connected. (If need, use the connector which is included in the indoor unit)
2. The BD should be installed inside the building.

Note : Due to our policy of innovation some specifications may be changed without notification.

Y Branch and Branch Kit

PMBL5620 (2 units) / PMBL1203F0 (3 units)





Features

- Y Branch and Branch kit make Multi FDX installation much easier.
- Y Branch and Branch kit for both gas and liquid are provided.
- Insulation material is also provided for covering the branches.

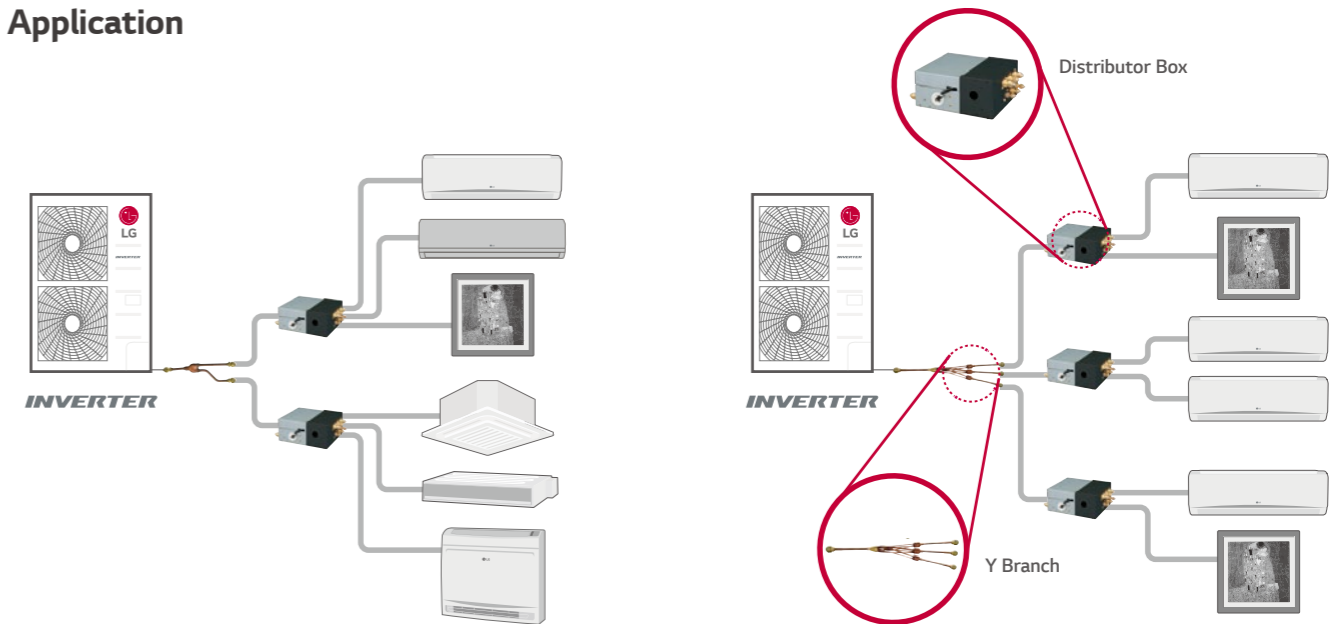
Application

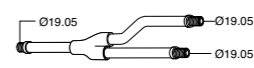
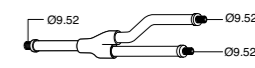

Accessory Model Name

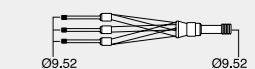
MODEL NAME	NO. OF BRANCH DISTRIBUTION UNITS	APPLICABLE MODEL	SPECIFICATION	
			GAS	Liquid
PMBL5620	2 Units	1Ø, 3Ø		
PMBL1203F0	3 Units	1Ø, 3Ø		

(Unit : mm)

INDIVIDUAL CONTROL SOLUTION

Control LG air conditioners via using the internet devices as Android or iOS bases smartphones

LG WI-FI MODEM

PWFMDD200

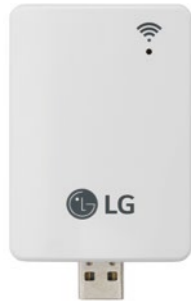

Features

- Access LG air conditioner anytime and from anywhere with Wi-Fi equipped device
- LG's exclusive Home Appliances control app(SmartThinQ) is available
- Simple operation for various functions

- On/Off
- Fan Speed
- Energy Monitoring ¹⁾
- Operation Mode
- Vane Control ²⁾
- Filter Management
- Current/Set Temperature
- Reservation (Sleep, Weekly On/Off)
- Error check

Model Name	PWFMDD200
Size (W x H x D, mm)	48 x 68 x 14
Interfaceable Products	Multi V Indoor unit ³⁾
Connection Type	Indoor unit 1:1
Communication Frequency	2.4 GHz
Wireless Standards	IEEE 802.11b/g/n
Mobile Application	LG SmartThinQ (Android v4.1 (Jellybean) or higher, iPhone iOS 9.0 or higher)
Optional Extension Cable	PWYREW000 (10m extension)

* Functionality may be different according to each IDU model
 * User interface of application shall be revised for its design and contents improvement
 * Application is optimized for smartphone use, so it may not be well functioning with tablet devices
 1) LG Centralized controller and PDI installation is required for this function
 2) Vane Control may not be possible according to the type of Indoor unit
 3) For the compatibility with Indoor unit, please contact regional office



Overview

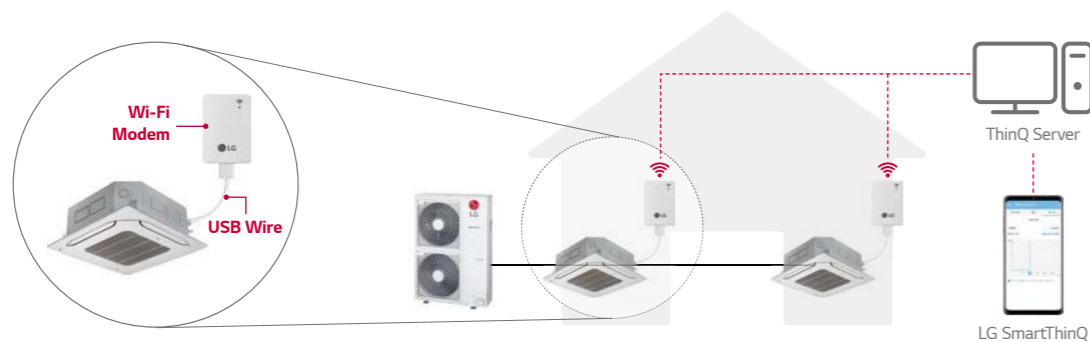

* Search "LG SmartThinQ" on Google market or Appstore then download the app.
 * Internet service with Wi-Fi connection has to be available

INDIVIDUAL CONTROL SOLUTION

WIRELESS REMOTE CONTROLLER

PQWRHQ0FDB



Features

Model Name	PQWRHQ0FDB
On / Off	•
Fan Speed Control	•
Temperature Setting	•
Mode Change	Cooling / Heating / Auto / Dehumidification / Fan
Additional Mode Setting	Plasma Purification / Energy-Saving Cooling / Robot Cleaning / Auto Dry
Auto Swing	•
Vane Control (Louver direction)	•
Reservation	Sleep / On / Off
Indoor Temperature Display	•
Sleep Mode Auto	Max. 7 hours
Size (W x H x D, mm)	51.4 x 153 x 26

INDIVIDUAL CONTROL SOLUTION

4.3 inch Color screen with a modern design

STANDARD III WIRED REMOTE CONTROLLER



PREMTB100 (White)

Model Name	PREMTB100 / PREMTBB10
On / Off	•
Fan Speed Control	•
Temperature Setting	•
Mode Change	Cooling / Heating / Auto / Dehumidification / Fan
Additional Mode Setting*	Plasma Purification / Energy-Saving Cooling / Robot Cleaning / Heater / Humidification / Comfort Cooling
Auto Swing	•
Vane Control (Louver direction)	•
E.S.P (External Static Pressure)**	•
Reservation	Simple / Sleep / On & Off timer / Weekly / Yearly / Holiday
Time Display	•
Electric Failure Compensation	•
Lock	All / On & Off / Mode / Set temperature range
Filter Sign	• (Remain time + Alarm)
Energy Management	Check Energy Usage*** / Check Operation Time / Target Setting (Energy, Operation Time) / Time Limit Operation / Alarm Popup / Initialization Usage Data
Operation Status LED	•
Indoor Temperature Display	•
Indoor Humidity Display	•
Display	4.3 inch TFT color LCD (480 x 272)
Size (W x H x D, mm)	120 x 120 x 16
Black light for Screen saver	•
Home Leave	2 set points control

INDIVIDUAL CONTROL SOLUTION

A simple way to control office or hotel systems in a compact design

SIMPLE WIRED REMOTE CONTROLLER



Simple

Simple for Hotel

Simple
PQRCVCLOQW (White) /

Simple for Hotel
PQRCHCAOQW (White) /

Features¹⁾

Model Name	PQRCVCLOQW / PQRCVCLOQ	PQRCHCAOQW / PQRCHCAOQ
On / Off	•	•
Fan Speed Control	•	•
Temperature Setting	•	•
Mode Change	Cooling / Heating / Auto / Dehumidification / Fan	Only Changeable by Central Controller
Auto Swing	•	-
Vane Control (Louver direction)	•	-
E.S.P (External Static Pressure)	•	•
Electric Failure Compensation	•	-
Child Lock	•	•
Indoor Temperature Display	•	•
Wireless Remote Controller Receiver	•*	•*
Size (W x H x D, mm)	70 x 121 x 16	70 x 121 x 16
Backlight	•	•

* For ceiling type duct

1) Indoor unit needs to have functions requested by the controller

INDIVIDUAL CONTROL SOLUTION

Providing easy control of one or a group of indoor units with various functions

STANDARD II WIRED REMOTE CONTROLLER



Standard II
PREMTB001 (White) / PREMTB01 (Black)

Features¹⁾

Model Name	PREMTB001 / PREMTB01
On / Off	•
Fan Speed Control	•
Temperature Setting	•
Mode Change	Cooling / Heating / Auto / Dehumidification / Fan
Additional Mode Setting	Plasma Purification / Energy-Saving Cooling / Robot Cleaning / Heater / Humidification
Auto Swing	•
Vane Control (Louver direction)	•
E.S.P (External Static Pressure)	•
Reservation	Simple / Sleep / On / Off / Weekly / Holiday
Time Display	•
Electric Failure Compensation	•
Child Lock	•
Filter Sign	• (Remain time + Alarm)
Operation Status LED	•
Indoor Temperature Display	•
Wireless Remote Controller Receiver	•*
Size (W x H x D, mm)	120 x 121 x 16
Blacklight	•
Power Consumption Monitoring	•**
Check Model Information	•

* For ceiling type duct
** LG centralized controller (available from AC Ez Touch or higher model) with PDI (PQNUD1S40 / PPWRDB000) installation is required for this function
1) Indoor unit needs to have functions requested by the controller

INDIVIDUAL CONTROL SOLUTION

5 inch full touch screen with a premium design

PREMIUM WIRED REMOTE CONTROLLER



PREMTA000¹⁾
1) English / Portuguese / Spanish / French

Features²⁾

Self-Management for Energy Saving

- Time limit operation / Power consumption monitoring
- Weekly / Monthly / Yearly trend tracking
- Target alert alarm
- Temperature range setting

Improved Scheduling

- Timer / Daily / Weekly / Yearly / Holiday

2 Set Points Control³⁾

Design with User's Convenience

- Full touch / Intuitive GUI (Graphic User Interface)
- Main display simple mode / Touch buzzer

Model Name	PREMTA000 / PREMTA000A / PREMTA000B
On / Off	•
Fan Speed Control	•
Temperature Setting	•
Mode Change	Cooling / Heating / Auto / Dehumidification / Fan
Additional Mode Setting*	Plasma Purification / Energy-Saving Cooling / Robot Cleaning / Heater / Humidification
Auto Swing	•
Vane Control (Louver direction)	•
E.S.P (External Static Pressure)**	•
Reservation	Simple / Sleep / On / Off / Weekly / Yearly / Holiday
Time Display	•
Electric Failure Compensation	•
Child Lock	•
Filter Sign	• (Remain time + Alarm)
Energy Management	Check Energy Usage*** / Check Operation Time / Target Setting (Energy, Operation Time) / Time Limit Operation / Alarm Popup / Initialization Usage Data
Operation Status LED	•
Indoor Temperature Display	•
Wireless Remote Controller Receiver	•****
Display	5 Inch TFT color LCD (480 x 272)
Size (W x H x D, mm)	137 x 121 x 16.5
Black Light for Screen Saver	•
Home Leave	2 Set Points Control

*It might not be indicated or operated at the partial product
** This function is available for certain indoor unit type
*** LG centralized controller (available from AC Ez Touch or higher model) with PDI (PQNUD1S40 / PPWRDB000) installation is required for this function
**** For ceiling type duct
2) Indoor unit needs to have functions requested by the controller
3) 2 set points control works normally with MULT V Heat Recovery and Single Split Heat Pump. But in case of MULTI V Heat Pump, it may not work properly

COMBINATION TABLE

A2UW16GFA2

Operation	Combination (kBtu/h)			Cooling								Total Input (W)		
				Each Capacity (kW)		Total Capacity								
	UNIT-A	UNIT-B	Total	UNIT-A	UNIT-B	Min		Rated		Max		Min	Rated	Max
1 UNIT	7		7	2.1	-	4,200	1.2	7,000	2.1	8,050	2.4	307	547	692
	9		9	2.6	-	5,400	1.6	9,000	2.6	10,350	3.0	412	684	875
	12		12	3.5	-	7,200	2.1	12,000	3.5	13,800	4.0	547	937	1,190
2 UNIT	7	7	14	2.1	2.1	8,400	2.5	14,000	4.1	16,100	4.7	591	1,000	1,379
	7	9	16	2.1	2.6	9,600	2.8	16,000	4.7	18,400	5.4	665	1,253	1,699
	9	9	18	2.3	2.3	9,600	2.8	16,000	4.7	18,400	5.4	665	1,253	1,699
	7	12	19	1.7	3.0	9,600	2.8	16,000	4.7	18,400	5.4	665	1,253	1,699
	9	12	21	2.0	2.7	9,600	2.8	16,000	4.7	18,400	5.4	665	1,253	1,699
	12	12	24	2.3	2.3	9,600	2.8	16,000	4.7	18,400	5.4	665	1,253	1,699

Operation	Combination (kBtu/h)			Heating								Total Input (W)		
				Each Capacity (kW)		Total Capacity								
	UNIT-A	UNIT-B	Total	UNIT-A	UNIT-B	Min		Rated		Max		Min	Rated	Max
1 UNIT	7		7	2.5	-	5,040	1.5	8,400	2.5	9,240	2.7	355	604	721
	9		9	3.2	-	6,480	1.9	10,800	3.2	11,880	3.5	454	758	920
	12		12	3.9	-	7,920	2.3	13,200	3.9	14,520	4.3	554	942	1,155
2 UNIT	7	7	14	2.3	2.3	9,600	2.8	16,000	4.7	18,400	5.4	613	1,068	1,451
	7	9	16	2.3	3.0	10,800	3.2	18,000	5.3	19,400	5.7	706	1,197	1,652
	9	9	18	2.6	2.6	10,800	3.2	18,000	5.3	19,400	5.7	706	1,197	1,652
	7	12	19	1.9	3.3	10,800	3.2	18,000	5.3	19,400	5.7	706	1,197	1,652
	9	12	21	2.3	3.0	10,800	3.2	18,000	5.3	19,400	5.7	706	1,197	1,652
	12	12	24	2.6	2.6	10,800	3.2	18,000	5.3	19,400	5.7	706	1,197	1,652

A3UW21GFA2

Operation	Combination (kBtu/h)				Cooling											Total Input (W)		
					Each Capacity (kW)			Total Capacity										
	UNIT-A	UNIT-B	UNIT-C	Total	UNIT-A	UNIT-B	UNIT-C	Min		Rated		Max		Min	Rated	Max		
1 UNIT	7			7	2.1	-	-	4,200	1.2	7,000	2.1	8,400	2.5	280	503	667		
	9			9	2.6	-	-	5,400	1.6	9,000	2.6	10,800	3.2	378	633	872		
	12			12	3.5	-	-	7,200	2.1	12,000	3.5	14,400	4.2	503	875	1,179		
	18			18	5.3	-	-	10,800	3.2	18,000	5.3	21,600	6.3	793	1,398	1,890		
2 UNIT	7	7		14	2.1	2.1	-	8,400	2.5	14,000	4.1	16,800	4.9	576	991	1,335		
	7	9		16	2.1	2.6	-	9,600	2.8	16,000	4.7	19,200	5.6	651	1,157	1,573		
	9	9		18	2.6	2.6	-	10,800	3.2	18,000	5.3	21,600	6.3	753	1,328	1,842		
	7	12		19	2.1	3.5	-	11,400	3.3	19,000	5.6	22,800	6.7	779	1,430	2,039		
	9	12		21	2.6	3.5	-	12,600	3.7	21,000	6.2	23,100	6.8	884	1,632	2,091		
	12	12		24	3.1	3.1	-	12,600	3.7	21,000	6.2	23,100	6.8	884	1,632	2,091		
	7	18		25	1.7	4.4	-	12,600	3.7	21,000	6.2	23,100	6.8	884	1,632	2,091		
	9	18		27	2.1	4.1	-	12,600	3.7	21,000	6.2	23,100	6.8	884	1,632	2,091		
	12	18		30	2.5	3.7	-	12,600	3.7	21,000	6.2	23,100	6.8	884	1,632	2,091		
	7	7	7	21	2.1	2.1	2.1	12,600	3.7	21,000	6.2	25,000	7.3	840	1,550	2,169		
	7	7	9	23	1.9	1.9	2.4	12,600	3.7	21,000	6.2	25,000	7.3	840	1,550	2,169		
	7	9	9	25	1.7	2.2	2.2	12,600	3.7	21,000	6.2	25,000	7.3	840	1,550	2,169		
7	7	12	26	1.7	1.7	2.8	12,600	3.7	21,000	6.2	25,000	7.3	840	1,550	2,169			
9	9	9	27	2.1	2.1	2.1	12,600	3.7	21,000	6.2	25,000	7.3	840	1,550	2,169			
7	9	12	28	1.5	2.0	2.6	12,600	3.7	21,000	6.2	25,000	7.3	840	1,550	2,169			
9	9	12	30	1.8	1.8	2.5	12,600	3.7	21,000	6.2	25,000	7.3	840	1,550	2,169			
7	12	12	31	1.4	2.4	2.4	12,600	3.7	21,000	6.2	25,000	7.3	840	1,550	2,169			
7	7	18	32	1.3	1.3	3.5	12,600	3.7	21,000	6.2	25,000	7.3	840	1,550	2,169			
9	12	12	33	1.7	2.2	2.2	12,600	3.7	21,000	6.2	25,000	7.3	840	1,550	2,169			

COMBINATION TABLE

A5UW30GFA2

Operation	Combination (kBtu/h)						Heating															
							Each Capacity (kW)					Total Capacity						Total Input (W)				
	UNIT-A	UNIT-B	UNIT-C	UNIT-D	UNIT-E	Total	UNIT-A	UNIT-B	UNIT-C	UNIT-D	UNIT-E	Min		Rated		Max		Min	Rated	Max		
												Btu/h	kW	Btu/h	kW	Btu/h	kW				Btu/h	kW
1 UNIT	5					5,000	1.5	5,500	1.6	6,325	1.9	610	610	747								
	7					5,000	1.6	8,400	2.5	9,660	2.8	610	665	862								
	9					6,480	1.9	10,800	3.2	12,420	3.6	610	864	1,126								
	12					7,920	2.3	13,200	3.9	15,180	4.4	610	1,067	1,399								
	15					9,900	2.9	16,500	4.8	18,975	5.6	778	1,337	1,823								
	18					11,880	3.5	19,800	5.8	22,770	6.7	950	1,649	2,230								
	24					15,240	4.5	25,400	7.4	26,670	7.8	1,246	2,172	2,654								
	5	5					7,200	2.1	12,000	3.5	14,400	4.2	471	808	1,130							
	5	7					8,640	2.5	14,400	4.2	17,280	5.1	566	983	1,397							
	5	9					10,080	3.0	16,800	4.9	20,160	5.9	685	1,163	1,643							
	7	7					10,080	3.0	16,800	4.9	20,160	5.9	685	1,163	1,643							
	7	9					11,520	3.4	19,200	5.6	23,040	6.8	783	1,348	1,928							
5	12					12,240	3.6	20,400	6.0	24,480	7.2	832	1,456	2,057								
9	9					12,960	3.8	21,600	6.3	25,920	7.6	882	1,537	2,189								
7	12					13,680	4.0	22,800	6.7	27,360	8.0	932	1,648	2,323								
5	15					14,400	4.2	24,000	7.0	28,800	8.4	983	1,732	2,459								
9	12					15,120	4.4	25,200	7.4	30,240	8.9	1,034	1,846	2,644								
7	15					15,840	4.6	26,400	7.7	31,680	9.3	1,085	1,932	2,877								
5	18					16,560	4.9	27,600	8.1	33,120	9.7	1,163	2,049	3,200								
9	15					17,280	5.1	28,800	8.4	34,560	10.1	1,215	2,138	3,554								
12	12					17,280	5.1	28,800	8.4	34,560	10.1	1,215	2,138	3,554								
7	18					18,000	5.3	30,000	8.8	34,560	10.1	1,268	2,267	3,554								
9	18					19,440	5.7	32,400	9.5	34,560	10.1	1,374	2,639	3,554								
12	15					19,440	5.7	32,400	9.5	34,560	10.1	1,374	2,639	3,554								
5	24					20,700	6.1	34,500	10.1	34,560	10.1	1,483	3,091	3,554								
12	18					20,700	6.1	34,500	10.1	34,560	10.1	1,483	3,091	3,554								
15	15					20,700	6.1	34,500	10.1	34,560	10.1	1,483	3,091	3,554								
7	24					20,700	6.1	34,500	10.1	34,560	10.1	1,483	3,091	3,554								
9	24					20,700	6.1	34,500	10.1	34,560	10.1	1,483	3,091	3,554								
15	18					20,700	6.1	34,500	10.1	34,560	10.1	1,483	3,091	3,554								
18	18					20,700	6.1	34,500	10.1	34,560	10.1	1,483	3,091	3,554								
12	24					20,700	6.1	34,500	10.1	34,560	10.1	1,483	3,091	3,554								
15	24					20,700	6.1	34,500	10.1	34,560	10.1	1,483	3,091	3,554								
18	24					20,700	6.1	34,500	10.1	34,560	10.1	1,483	3,091	3,554								
24	24					20,700	6.1	34,500	10.1	34,560	10.1	1,483	3,091	3,554								
5	5	5				18,000	3.2	18,000	5.3	21,600	6.3	690	1,192	1,662								
5	5	7				12,240	3.6	20,400	6.0	24,480	7.2	782	1,368	1,934								
5	5	9				13,680	4.0	22,800	6.7	27,360	8.0	876	1,549	2,183								
5	7	7				13,680	4.0	22,800	6.7	27,360	8.0	876	1,549	2,183								
7	7	9				15,120	4.4	25,200	7.4	30,240	8.9	972	1,735	2,486								
7	7	7				15,120	4.4	25,200	7.4	30,240	8.9	972	1,735	2,486								
5	5	12				15,840	4.6	26,400	7.7	31,680	9.3	1,020	1,817	2,650								
5	9	9				16,560	4.9	27,600	8.1	33,120	9.7	1,093	1,926	2,831								
5	7	9				16,560	4.9	27,600	8.1	33,120	9.7	1,093	1,926	2,831								
7	7	12				17,280	5.1	28,800	8.4	34,560	10.1	1,142	2,010	3,020								
7	5	15				18,000	5.3	30,000	8.8	36,000	10.6	1,192	2,131	3,266								
5	9	12				18,000	5.3	30,000	8.8	36,000	10.6	1,192	2,131	3,266								
5	9	12				18,720	5.5	31,200	9.1	37,440	11.0	1,242	2,228	3,472								
7	7	15				18,720	5.5	31,200	9.1	37,440	11.0	1,242	2,228	3,472								
7	7	15				19,440	5.7	32,400	9.5	38,640	11.3	1,292	2,382	3,686								
9	9	9				19,440	5.7	32,400	9.5	38,640	11.3	1,292	2,382	3,686								
7	9	12				20,160	5.9	33,600	9.8	38,640	11.3	1,343	2,502	3,686								
5	5	18				20,160	5.9	33,600	9.8	38,640	11.3	1,343	2,502	3,686								
5	9	15				20,700	6.1	34,500	10.1	38,640	11.3	1,394	2,626	3,686								
5	12	12				20,700	6.1	34,500	10.1	38,640	11.3	1,394	2,626	3,686								
7	7	15				20,700	6.1	34,500	10.1	38,640	11.3	1,394	2,626	3,686								
9	9	12				20,700	6.1	34,500	10.1	38,640	11.3	1,394	2,626	3,686								
5	7	18				20,700	6.1	34,500	10.1	38,640	11.3	1,394	2,626	3,686								
9	9	12				20,700	6.1	34,500	10.1	38,640	11.3	1,394	2,626	3,686								
7	9	15				20,700	6.1	34,500	10.1	38,640	11.3	1,394	2,626	3,686								
7	12	12				20,700	6.1	34,500	10.1	38,640	11.3	1,394	2,626	3,686								
5	12	15				20,700	6.1	34,500	10.1	38,640	11.3	1,394	2,626	3,686								
5	9	18				20,700	6.1	34,500	10.1	38,640	11.3	1,394	2,626	3,686								
7	7	18				20,700	6.1	34,500	10.1	38,640	11.3	1,394	2,626	3,686								
9	9	12				20,700	6.1	34,500	10.1	38,640	11.3	1,394	2,626	3,686								
7	9	15				20,700	6.1	34,500	10.1	38,640	11.3	1,394	2,626	3,686								
7	12	12				20,700	6.1	34,500	10.1	38,640	11.3	1,394	2,626	3,686								
5	12	15				20,700	6.1	34,500	10.1	38,640	11.3	1,394	2,626	3,686								
5	15	15				20,700	6.1	34,500	10.1	38,640	11.3	1,394	2,626	3,686								
7	9	24				20,700	6.1	34,500	10.1	38,640	11.3	1,394	2,626	3,686								
9	12	18				20,700	6.1	34,500	10.1	38,640	11.3	1,394	2,626	3,686								
9	15	15				20,700	6.1	34,500	10.1	38,640	11.3	1,394	2,626	3,686								
12	12	15				20,700	6.1	34,500	10.1	38,640	11.3	1,394	2,626	3,686								
7	9	24				20,700	6.1	34,500	10.1	38,640	11.3	1,394	2,626	3,686								
7	15	18				20,700	6.1	34,500	10.1	38,640	11.3	1,394	2,626	3,686								
5	12	24				20,700	6.1	34,500	10.1	38,640	11.3	1,394	2,626	3,686								
5	18	18				20,700	6.1	34,500	10.1	38,640	11.3	1,394	2,626	3,686								
12	12	18				20,700	6.1	34,500	10.1	38,640	11.3	1,394	2,626	3,686								
9	9	24				20,700	6.1	34,500	10.1	38,640	11.3	1,394	2,626	3,6								

COMBINATION TABLE

A5UW30GFA2

Operation	Combination (kBtu/h)						Heating										Total Input (W)			
							Each Capacity (kW)					Total Capacity								
	UNIT-A	UNIT-B	UNIT-C	UNIT-D	UNIT-E	Total	UNIT-A	UNIT-B	UNIT-C	UNIT-D	UNIT-E	Min		Rated		Max				
5	5	5	5	5	5	25	1.8	1.8	1.8	1.8	1.8	18,000	5.3	30,000	8.8	36,000	10.6	1,092	1,944	2,877
5	5	5	5	7	27	1.8	1.8	1.8	1.8	2.5	19,440	5.7	32,400	9.5	38,880	11.4	1,184	2,129	3,300	
5	5	5	5	9	29	1.7	1.7	1.7	1.7	3.1	20,700	6.1	34,500	10.1	41,400	12.1	1,277	2,290	3,705	
5	5	5	7	7	29	1.7	1.7	1.7	2.4	2.4	20,700	6.1	34,500	10.1	41,400	12.1	1,277	2,290	3,705	
5	5	5	7	9	31	1.6	1.6	1.6	2.3	2.9	20,700	6.1	34,500	10.1	41,400	12.1	1,277	2,290	3,705	
5	5	5	7	7	31	1.6	1.6	2.3	2.3	2.3	20,700	6.1	34,500	10.1	41,400	12.1	1,277	2,290	3,705	
5	5	5	5	12	32	1.6	1.6	1.6	1.6	3.8	20,700	6.1	34,500	10.1	41,400	12.1	1,277	2,290	3,705	
5	5	5	9	9	33	1.5	1.5	1.5	2.8	2.8	20,700	6.1	34,500	10.1	41,400	12.1	1,277	2,290	3,705	
5	5	5	7	7	33	1.5	1.5	2.1	2.1	2.8	20,700	6.1	34,500	10.1	41,400	12.1	1,277	2,290	3,705	
5	5	5	7	7	33	1.5	2.1	2.1	2.1	2.1	20,700	6.1	34,500	10.1	41,400	12.1	1,277	2,290	3,705	
5	5	5	5	12	34	1.5	1.5	1.5	1.5	3.6	20,700	6.1	34,500	10.1	41,400	12.1	1,277	2,290	3,705	
5	5	5	5	15	35	1.4	1.4	1.4	1.4	4.3	20,700	6.1	34,500	10.1	41,400	12.1	1,277	2,290	3,705	
5	5	7	7	9	35	1.4	2.0	2.0	2.0	2.6	20,700	6.1	34,500	10.1	41,400	12.1	1,277	2,290	3,705	
5	5	7	7	7	35	2.0	2.0	2.0	2.0	2.0	20,700	6.1	34,500	10.1	41,400	12.1	1,277	2,290	3,705	
5	5	5	9	12	36	1.4	1.4	1.4	2.5	3.4	20,700	6.1	34,500	10.1	41,400	12.1	1,277	2,290	3,705	
5	5	7	7	12	36	1.4	1.4	2.0	2.0	3.4	20,700	6.1	34,500	10.1	41,400	12.1	1,277	2,290	3,705	
5	5	5	5	15	37	1.4	1.4	1.4	1.9	4.1	20,700	6.1	34,500	10.1	41,400	12.1	1,277	2,290	3,705	
5	5	5	9	9	37	1.4	1.4	2.5	2.5	2.5	20,700	6.1	34,500	10.1	41,400	12.1	1,277	2,290	3,705	
5	5	7	7	9	37	1.4	1.9	1.9	2.5	2.5	20,700	6.1	34,500	10.1	41,400	12.1	1,277	2,290	3,705	
5	5	7	7	7	37	1.9	1.9	1.9	1.9	2.5	20,700	6.1	34,500	10.1	41,400	12.1	1,277	2,290	3,705	
5	5	5	5	18	38	1.3	1.3	1.3	1.3	4.8	20,700	6.1	34,500	10.1	41,400	12.1	1,277	2,290	3,705	
5	5	7	7	12	38	1.3	1.9	1.9	1.9	3.2	20,700	6.1	34,500	10.1	41,400	12.1	1,277	2,290	3,705	
5	5	5	5	9	39	1.3	1.3	1.3	2.3	3.9	20,700	6.1	34,500	10.1	41,400	12.1	1,277	2,290	3,705	
5	5	5	5	12	39	1.3	1.3	1.3	3.1	3.1	20,700	6.1	34,500	10.1	41,400	12.1	1,277	2,290	3,705	
5	5	5	7	15	39	1.3	1.3	1.8	1.8	3.9	20,700	6.1	34,500	10.1	41,400	12.1	1,277	2,290	3,705	
5	7	7	7	9	39	1.8	1.8	1.8	2.3	2.3	20,700	6.1	34,500	10.1	41,400	12.1	1,277	2,290	3,705	
5	5	5	5	9	39	1.3	1.8	2.3	2.3	2.3	20,700	6.1	34,500	10.1	41,400	12.1	1,277	2,290	3,705	
5	5	5	5	7	40	1.3	1.3	1.3	1.8	4.6	20,700	6.1	34,500	10.1	41,400	12.1	1,277	2,290	3,705	
5	5	5	9	12	40	1.3	1.3	2.3	2.3	3.0	20,700	6.1	34,500	10.1	41,400	12.1	1,277	2,290	3,705	
5	5	7	7	9	40	1.3	1.8	1.8	2.3	3.0	20,700	6.1	34,500	10.1	41,400	12.1	1,277	2,290	3,705	
5	5	7	7	12	40	1.8	1.8	1.8	1.8	3.0	20,700	6.1	34,500	10.1	41,400	12.1	1,277	2,290	3,705	
5	5	7	9	15	41	1.2	1.2	1.7	2.2	3.7	20,700	6.1	34,500	10.1	41,400	12.1	1,277	2,290	3,705	
5	5	7	7	15	41	1.2	1.7	1.7	1.7	3.7	20,700	6.1	34,500	10.1	41,400	12.1	1,277	2,290	3,705	
5	9	9	9	9	41	1.2	2.2	2.2	2.2	2.2	20,700	6.1	34,500	10.1	41,400	12.1	1,277	2,290	3,705	
5	7	7	9	9	41	1.7	1.7	2.2	2.2	2.2	20,700	6.1	34,500	10.1	41,400	12.1	1,277	2,290	3,705	
5	5	5	5	18	42	1.2	1.2	1.2	2.2	4.3	20,700	6.1	34,500	10.1	41,400	12.1	1,277	2,290	3,705	
5	5	5	5	12	42	1.2	1.2	1.2	2.9	3.6	20,700	6.1	34,500	10.1	41,400	12.1	1,277	2,290	3,705	
5	5	7	7	18	42	1.2	1.2	1.7	1.7	4.3	20,700	6.1	34,500	10.1	41,400	12.1	1,277	2,290	3,705	
5	5	7	9	12	42	1.2	1.7	2.2	2.2	2.9	20,700	6.1	34,500	10.1	41,400	12.1	1,277	2,290	3,705	
5	5	9	9	12	43	1.2	1.2	2.1	2.1	3.5	20,700	6.1	34,500	10.1	41,400	12.1	1,277	2,290	3,705	
5	5	7	7	15	43	1.2	1.6	1.6	2.1	3.5	20,700	6.1	34,500	10.1	41,400	12.1	1,277	2,290	3,705	
5	5	7	12	12	43	1.2	1.6	1.6	2.8	2.8	20,700	6.1	34,500	10.1	41,400	12.1	1,277	2,290	3,705	
5	7	7	7	15	43	1.6	1.6	1.6	1.6	3.5	20,700	6.1	34,500	10.1	41,400	12.1	1,277	2,290	3,705	
5	7	9	9	9	43	1.6	2.1	2.1	2.1	2.1	20,700	6.1	34,500	10.1	41,400	12.1	1,277	2,290	3,705	
5	5	5	12	15	44	1.1	1.1	1.6	2.8	3.4	20,700	6.1	34,500	10.1	41,400	12.1	1,277	2,290	3,705	
5	5	7	7	18	44	1.1	1.1	1.1	1.1	5.5	20,700	6.1	34,500	10.1	41,400	12.1	1,277	2,290	3,705	
5	5	7	7	18	44	1.1	1.6	1.6	1.6	4.1	20,700	6.1	34,500	10.1	41,400	12.1	1,277	2,290	3,705	
5	9	9	9	9	44	1.1	2.1	2.1	2.1	2.8	20,700	6.1	34,500	10.1	41,400	12.1	1,277	2,290	3,705	
5	5	5	12	12	44	1.6	1.6	2.1	2.1	2.8	20,700	6.1	34,500	10.1	41,400	12.1	1,277	2,290	3,705	
5	5	5	15	15	45	1.1	1.1	1.1	2.7	4.0	20,700	6.1	34,500	10.1	41,400	12.1	1,277	2,290	3,705	
5	5	5	5	15	45	1.1	1.1	1.1	3.4	3.4	20,700	6.1	34,500	10.1	41,400	12.1	1,277	2,290	3,705	
5	7	9	9	9	45	1.1	1.6	2.0	2.0	3.4	20,700	6.1	34,500	10.1	41,400	12.1	1,277	2,290	3,705	
5	7	9	12	12	45	1.1	1.6	2.0	2.7	2.7	20,700	6.1	34,500	10.1	41,400	12.1	1,277	2,290	3,705	
7	7	7	7	9	45	1.6	1.6	1.6	2.0	3.4	20,700	6.1	34,500	10.1	41,400	12.1	1,277	2,290	3,705	
7	7	7	12	12	45	1.6	1.6	1.6	2.7	2.7	20,700	6.1	34,500	10.1	41,400	12.1	1,277	2,290	3,705	
9	9	9	9	9	45	2.0	2.0	2.0	2.0	2.0	20,700	6.1	34,500	10.1	41,400	12.1	1,277	2,290	3,705	
5	5	5	7	24	46	1.1	1.1	1.1	1.5	5.3	20,700	6.1	34,500	10.1	41,400	12.1	1,277	2,290	3,705	
5	5	5	9	18	46	1.1	1.1	2.0	2.0	4.0	20,700	6.1	34,500	10.1	41,400	12.1	1,277	2,290	3,705	
5	5	9	12	15	46	1.1	1.1	2.0	2.6	3.3	20,700	6.1	34,500	10.1	41,400	12.1	1,277	2,290	3,705	
5	5	12	12	12	46	1.1	1.1	2.6	2.6	2.6	20,700	6.1	34,500	10.1	41,400	12.1	1,277	2,290	3,705	
5	5	7	7	18	46	1.1	1.5	1.5	2.0	4.0	20,700	6.1	34,500	10.1	41,400	12.1	1,277	2,290	3,705	
5	7	7	12	15	46	1.1	1.5	1.5	2.6	3.3	20,700	6.1	34,500	10.1	41,400	12.1	1,277	2,290	3,705	
7	7	7	7	18	46	1.5	1.5	1.5	1.5	4.0	20,700	6.1	34,500	10.1	41,400	12.1	1,277	2,290	3,705	
7	9	9	9	12	46	1.5	2.0	2.0	2.6	2.6	20,700	6.1	34,500	10.1	41,400	12.1	1,277	2,290	3,705	
5	5	7	15	15	47	1.1	1.1	1.5	3.2	3.2	20,700	6.1	34,500	10.1	41,400	12.1	1,277	2,290	3,705	
5	5	9	9	15	47	1.1	1.9	1.9	1.9	3.2	20,700	6.1	34,500	10.1	41,400	12.1	1,277	2,290	3,705	
5	5	9	12	12	47	1.1	1.9	1.9	2.6	2.6	20,700	6.1	34,500	10.1	41,400	12.1	1,277	2,290	3,705	
7	7	9	9	15	47	1.5	1.5	1.9	1.9	3.2	20,700	6.1	34,500	10.1	41,400	12.1	1,277	2,290	3,705	
7	7	9	12	12	47	1.5	1.5	1.9	2.6	2.6	20,700	6.1	34,500	10.1	41,400	12.1	1,277	2,290	3,705	
5	5	5	9	24	48	1.1	1.1	1.1	1.1	5.1	20,700	6.1	34,500	10.1	41,400	12.1				

COMBINATION TABLE

A5UW40GFA0

Operation	Combination (kBtu/h)						Cooling									Total Input (W)			
							Each Capacity (kW)					Total Capacity							
	UNIT-A	UNIT-B	UNIT-C	UNIT-D	UNIT-E	Total	UNIT-A	UNIT-B	UNIT-C	UNIT-D	UNIT-E	Min	Rated	Max	Min	Rated	Max		
UNIT-A	UNIT-B	UNIT-C	UNIT-D	UNIT-E	Total	UNIT-A	UNIT-B	UNIT-C	UNIT-D	UNIT-E	Btu/h	kW	Btu/h	kW	Btu/h	kW	Min	Rated	Max
5	5	5	5	5	20	1.5	1.5	1.5	1.5	-	12,000	3.5	20,000	5.9	24,000	7.0	868	1,400	2,128
5	5	5	5	7	22	1.5	1.5	1.5	2.0	-	13,200	3.9	22,000	6.4	26,400	7.7	955	1,540	2,347
5	5	5	5	9	24	1.5	1.5	1.5	2.6	-	14,400	4.2	24,000	7.0	28,800	8.4	1,042	1,680	2,554
5	5	5	7	7	24	1.5	1.5	2.0	2.0	-	14,400	4.2	24,000	7.0	28,800	8.4	1,042	1,680	2,554
5	5	5	7	9	26	1.5	1.5	2.0	2.6	-	15,600	4.6	26,000	7.6	31,200	9.1	1,128	1,820	2,767
5	5	7	7	7	26	1.5	2.0	2.0	2.0	-	15,600	4.6	26,000	7.6	31,200	9.1	1,128	1,820	2,767
5	5	5	5	12	27	1.5	1.5	1.5	3.5	-	16,200	4.7	27,000	7.9	32,400	9.5	1,172	1,890	2,873
5	5	5	7	9	28	1.5	1.5	2.6	2.6	-	16,800	4.9	28,000	8.2	33,600	9.8	1,215	1,960	2,979
5	5	7	7	9	28	1.5	2.1	2.1	2.6	-	16,800	4.9	28,000	8.2	33,600	9.8	1,215	1,960	2,979
5	5	7	7	7	28	2.1	2.1	2.1	2.1	-	16,800	4.9	28,000	8.2	33,600	9.8	1,215	1,960	2,979
5	5	5	7	12	29	1.5	1.5	2.1	3.5	-	17,400	5.1	29,000	8.5	34,800	10.2	1,259	2,030	3,086
5	5	5	5	15	30	1.5	1.5	1.5	4.4	-	18,000	5.3	30,000	8.8	36,000	10.6	1,281	2,065	3,139
5	5	7	9	9	30	1.5	2.1	2.1	2.6	-	18,000	5.3	30,000	8.8	36,000	10.6	1,302	2,100	3,192
5	5	7	9	9	30	2.1	2.1	2.1	2.6	-	18,000	5.3	30,000	8.8	36,000	10.6	1,302	2,100	3,192
5	5	5	5	12	31	1.5	1.5	2.6	3.5	-	18,600	5.5	31,000	9.1	37,200	10.9	1,345	2,170	3,299
5	5	7	7	12	31	1.5	2.1	2.1	3.5	-	18,600	5.5	31,000	9.1	37,200	10.9	1,345	2,170	3,299
5	5	5	7	15	32	1.5	1.5	2.1	4.4	-	19,200	5.7	32,000	9.4	38,400	11.2	1,367	2,205	3,352
5	5	7	9	9	32	2.1	2.1	2.6	2.6	-	19,200	5.6	32,000	9.4	38,400	11.3	1,389	2,240	3,405
5	5	9	9	9	32	1.5	2.6	2.6	2.6	-	19,200	5.6	32,000	9.4	38,400	11.3	1,389	2,240	3,405
5	5	5	5	18	33	1.5	1.5	1.5	5.3	-	19,800	5.8	33,000	9.7	39,600	11.6	1,432	2,310	3,512
5	5	7	9	12	33	1.5	2.1	2.6	3.5	-	19,800	5.8	33,000	9.7	39,600	11.6	1,432	2,310	3,512
5	5	7	7	12	33	2.1	2.1	2.1	3.5	-	19,800	5.8	33,000	9.7	39,600	11.6	1,432	2,310	3,512
5	5	5	7	15	34	1.5	1.5	2.6	4.4	-	20,400	6.0	34,000	10.0	40,800	11.9	1,454	2,345	3,565
5	5	5	5	12	34	1.5	1.5	3.5	3.5	-	20,400	6.0	34,000	10.0	40,800	12.0	1,476	2,380	3,618
5	5	7	7	15	34	1.5	2.1	2.1	4.4	-	20,400	6.0	34,000	10.0	40,800	12.0	1,476	2,380	3,618
5	7	9	9	9	34	2.1	2.6	2.6	2.6	-	20,400	6.0	34,000	10.0	40,800	12.0	1,476	2,380	3,618
5	5	7	9	12	35	1.5	1.5	2.1	5.3	-	21,000	6.2	35,000	10.3	42,000	12.3	1,519	2,450	3,724
5	5	9	9	12	35	1.5	2.6	2.6	3.5	-	21,000	6.2	35,000	10.3	42,000	12.3	1,519	2,450	3,724
5	7	7	9	12	35	2.1	2.1	2.6	3.5	-	21,000	6.2	35,000	10.3	42,000	12.3	1,519	2,450	3,724
5	5	7	9	15	36	1.5	1.5	2.7	4.4	-	21,600	6.4	36,000	10.6	43,200	12.6	1,541	2,485	3,777
5	5	7	12	12	36	1.5	2.1	3.5	3.5	-	21,600	6.3	36,000	10.6	43,200	12.7	1,562	2,520	3,831
5	7	9	9	9	36	2.1	2.1	2.7	2.7	-	21,600	6.3	36,000	10.6	43,200	12.7	1,562	2,520	3,831
5	5	5	9	18	37	1.5	1.5	1.5	5.3	-	22,200	6.5	37,000	10.8	44,400	13.0	1,606	2,590	3,937
5	5	5	12	15	37	1.5	1.5	3.5	4.4	-	22,200	6.5	37,000	10.8	44,400	13.1	1,606	2,590	3,937
5	5	7	7	18	37	1.5	2.0	2.0	5.3	-	22,200	6.5	37,000	10.8	44,400	13.0	1,606	2,590	3,937
5	7	9	9	12	37	2.0	2.6	2.6	3.5	-	22,200	6.5	37,000	10.8	44,400	13.0	1,606	2,590	3,937
5	5	9	9	15	38	1.5	2.6	2.6	4.4	-	22,800	6.7	38,000	11.1	45,600	13.4	1,693	2,730	4,097
5	7	7	9	15	38	2.0	2.0	2.6	4.4	-	22,800	6.7	38,000	11.1	45,600	13.4	1,693	2,730	4,097
5	7	7	12	12	38	2.0	2.0	3.5	3.5	-	22,800	6.7	38,000	11.1	45,600	13.4	1,693	2,730	4,097
5	5	5	5	24	39	1.4	1.4	1.4	6.9	-	22,920	6.7	38,200	11.2	46,000	13.5	1,693	2,730	4,150
5	5	7	9	18	39	1.4	2.0	2.6	5.2	-	22,920	6.7	38,200	11.2	46,000	13.5	1,693	2,730	4,150
5	5	7	12	15	39	1.4	2.0	3.4	4.3	-	22,920	6.7	38,200	11.2	46,000	13.5	1,693	2,730	4,150
5	9	9	9	12	39	2.6	2.6	2.6	3.4	-	22,920	6.7	38,200	11.2	46,000	13.5	1,693	2,730	4,150
5	7	7	7	18	39	2.0	2.0	2.0	5.2	-	22,920	6.7	38,200	11.2	46,000	13.5	1,693	2,730	4,150
5	7	9	9	15	40	1.4	1.4	2.4	5.0	-	22,920	6.7	38,200	11.2	46,000	13.5	1,693	2,730	4,150
5	7	9	9	15	40	2.0	2.5	2.5	4.2	-	22,920	6.7	38,200	11.2	46,000	13.5	1,693	2,730	4,150
5	7	9	12	12	40	2.0	2.5	3.4	3.4	-	22,920	6.7	38,200	11.2	46,000	13.5	1,693	2,730	4,150
5	5	5	7	24	41	1.4	1.4	1.9	6.6	-	22,920	6.7	38,200	11.2	46,000	13.5	1,693	2,730	4,150
5	5	9	12	15	41	1.4	2.5	3.3	4.1	-	22,920	6.7	38,200	11.2	46,000	13.5	1,693	2,730	4,150
5	5	12	12	12	41	1.4	3.3	3.3	3.3	-	22,920	6.7	38,200	11.2	46,000	13.5	1,693	2,730	4,150
5	7	7	9	18	41	1.9	1.9	2.5	4.9	-	22,920	6.7	38,200	11.2	46,000	13.5	1,693	2,730	4,150
5	7	7	15	15	41	1.9	1.9	3.3	4.1	-	22,920	6.7	38,200	11.2	46,000	13.5	1,693	2,730	4,150
5	5	7	15	15	42	1.3	1.9	4.0	4.0	-	22,920	6.7	38,200	11.2	46,000	13.5	1,693	2,730	4,150
5	9	9	9	15	42	2.4	2.4	2.4	4.0	-	22,920	6.7	38,200	11.2	46,000	13.5	1,693	2,730	4,150
5	9	9	12	12	42	2.4	2.4	3.2	3.2	-	22,920	6.7	38,200	11.2	46,000	13.5	1,693	2,730	4,150
5	7	9	12	12	43	1.8	2.3	3.1	3.9	-	22,920	6.7	38,200	11.2	46,000	13.5	1,693	2,730	4,150
5	7	12	12	12	43	1.8	3.1	3.1	3.1	-	22,920	6.7	38,200	11.2	46,000	13.5	1,693	2,730	4,150
5	7	9	18	18	43	1.8	3.3	4.7	4.7	-	22,920	6.7	38,200	11.2	46,000	13.5	1,693	2,730	4,150
5	7	9	15	15	44	1.3	2.3	3.8	3.8	-	22,920	6.7	38,200	11.2	46,000	13.5	1,693	2,730	4,150
5	7	7	12	18	44	1.8	1.8	3.1	4.6	-	22,920	6.7	38,200	11.2	46,000	13.5	1,693	2,730	4,150
5	7	7	15	15	44	1.8	1.8	3.8	3.8	-	22,920	6.7	38,200	11.2	46,000	13.5	1,693	2,730	4,150
5	5	7	18	15	45	1.2	1.7	4.5	3.7	-	22,920	6.7	38,200	11.2	46,000	13.5	1,693	2,730	4,150
5	9	9	12	15	45	2.2	2.2	3.0	3.7	-	22,920	6.7	38,200	11.2	46,000	13.5	1,693	2,730	4,150
5	9	12	12	12	45	2.2	3.0	3.0	3.0	-	22,920	6.7	38,200	11.2	46,000	13.5	1,693	2,730	4,150
5	9	9	18	18	45	2.2	2.2	4.5	4.5	-	22,920	6.7	38,200	11.2	46,000	13.5	1,693	2,730	4,150
5	9	9	7	24	45	1.7	1.7	1.7	6.0	-	22,920	6.7	38,200	11.2	46,000	13.5	1,693	2,730	4,150
5	7	9	12	18	46	1.7	2.2	2.9	4.4	-	22,920	6.7	38,200	11.2	46,000	13.5	1,693	2,730	4,150
5	7	9	15	15	46	1.7	2.2	3.7	3.7	-	22,920	6.7	38,200	11.2	46,000	13.5	1,693	2,730	4,150
5	7	12	12	15	46	1.7	2.9	2.9	3.7	-	22,920	6.7	38,200	11.2	46,000	13.5	1,693	2,730	4,150
5	5	18	18	18	46	1.2	1.2	4.4	4.4	-	22,920	6.7	38,200	11.2	46,000	13.5	1,693	2,730	4,150
5	5	12	18	18	47</														

MULTI STANDARD

ADVANCED RESIDENTIAL SOLUTION



MULTI STANDARD

INDOOR UNITS KEY FEATURES

Why LG Multi Standard?

• Perfect solution for multiple rooms

✓ Adding value to home appearance

Don't let outdoor unit harm your home appearance. Multi split can make your home exterior tidy and neat with only one outdoor unit.



✓ 10-Year Inverter Compressor Warranty

The compressors is for the Air Conditioner what the engine is to the vehicle. With the 10-year warranty on the compressor, users can enjoy the benefits of LG air conditioner for a longer period on time.

Reliable Air Conditioner

Product safety is emphasized by offering a 10-year warranty on the compressor to reassure customers about product durability



Verification

Product safety is emphasized by offering a 10-year warranty on the compressor to reassure customers about product durability

* Long Term Accelerated-Reliability test

LG's unique testing method with reinforced operating condition for a product life assurance to test and determine the product life cycle in a short period of time by accelerating the life cycle.

* High Marginal Test

Test method to secure durability in various adverse conditions that may occur in the field by performing comp reliability test against higher pressure and temperature than the designed range of pressure and temperature which the comp operates in.

* Verification obtained from TUV Rheinland for 10-year product life cycle

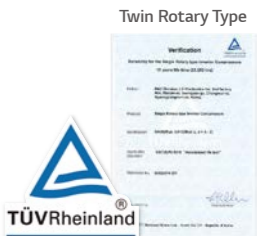

Operation	Outdoor Model	Combination (kBtu/h)			
		Unit-A	Unit-B	Unit-C	Total
2 Units	A2UW18GFAB	9	9	-	18
		9	12	-	21
		12	12	-	24
	A3UW24GFAB	9	12	-	21
		12	12	-	24
		12	24	-	36
3 Units	A3UW36GFAB	18	18	-	36
		9	9	9	27
		9	9	12	30
	A3UW24GFAB	9	12	12	33
		12	12	12	36
		9	12	18	39
A3UW36GFAB	12	12	18	42	
	12	12	24	48	

INDOOR UNITS KEY FEATURES

Dual Protection Filter

• What is the Dual Protection Filter?

The Dual Protection Filter, designed to capture dust particles over 10µm in size, is the first line of defense against finer particles.

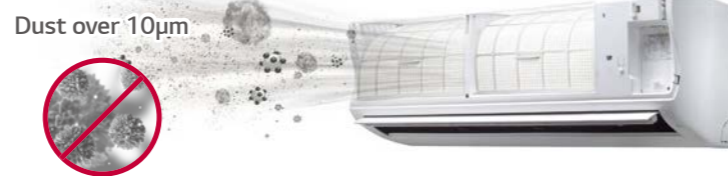

• Additional Benefit

The Dual Protection Filter, designed to capture dust particles over 10µm in size, is the first line of defense against finer particles.

Easy to Open

The simple full surface cover is detachable to make cleaning the air-conditioner much easier.



Easy to Clean

The filter is designed for easy handling and quick cleaning, which lengthens its lifespan.



Auto Cleaning

• Pain Point

The main cause of odor within air conditioners is mold and bacteria growing on the heat exchanger. These germs can spread when the heat exchanger is wet.



• Benefit

Removes Harmful Particles

Auto Cleaning provides clean air by preventing bacteria, mold and odors that can otherwise accumulate in an indoor unit.

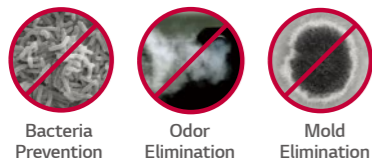

Jet Cool

• How It Works

One Click "Jet Mode"

Reduces the temperature of outflowing air to 18°C for 30 minutes with just one click.

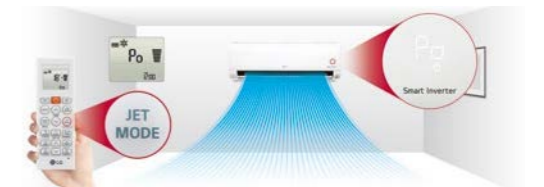

• More Powerful Performance

By reducing the second vortex, which decreases airflow within the air outlet, and enlarging the fan size, the amount of airflow is increased to 13.0 CMM.

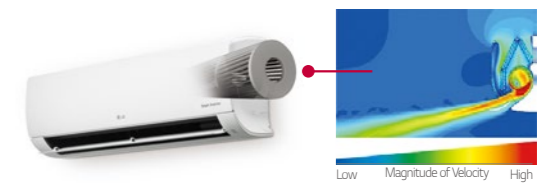

Comfort Air

• Concept

Having the air conditioner turned on while asleep can lower body temperature or cause discomfort, especially if the outflowing air is blowing directly onto a room's occupants. Comfort Air adjusts vane angle to prevent this, providing ultimate sleeping comfort.

• How It Works

Comfort Vane

This option conveniently sets an AC's louvers to a preset position so that outflowing air is directed away from a room's occupants.

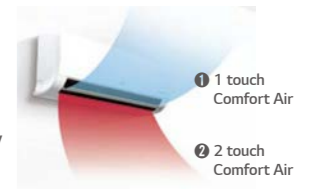

Quick & Easy Installation

• Concept

By reducing the manpower and time required for installation, it is now possible to install more units in less time.

• How It Works

Comfort Vane

This option conveniently sets an AC's louvers to a preset position so that outflowing air is directed away from a room's occupants.

- 1 One Simple Packing Box
- 2 Installation Plate Improvement
- 3 Installation Support Clip
- 4 Wider Tubing Space
- 5 Detachable Bottom Cover
- 6 Quick button for running test



OUTDOOR UNITS KEY FEATURES

Twin Rotary Inverter Compressor

Parts of Inverter Twin Rotary Compressor have been improved to allow for a longer life span.

- 1 Flow Optimization
- 2 Concentrated Winding Motor
- 3 Surface Coating
- 4 Concentrated Winding Motor
- 5 Twin Rotary Rotor

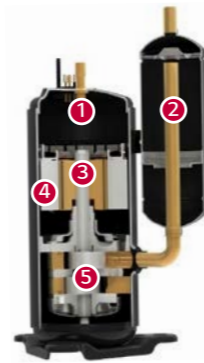

Black Fin Heat Exchanger

The black coating with enhanced epoxy resin is applied for strong protection from various corrosive external conditions such as salt contamination and air pollution including fumes from factories. Moreover, the hydrophilic film keeps water from accumulating on the heat exchanger's fin, minimizing moisture buildup and eventually making it even more corrosion resistant.

Hydrophilic film (Water flow)

The Hydrophilic coating minimizes moisture buildup on the fin.

Epoxy resin (Corrosion resistant)

The Black coating provides strong protection from corrosion.

Aluminum fin

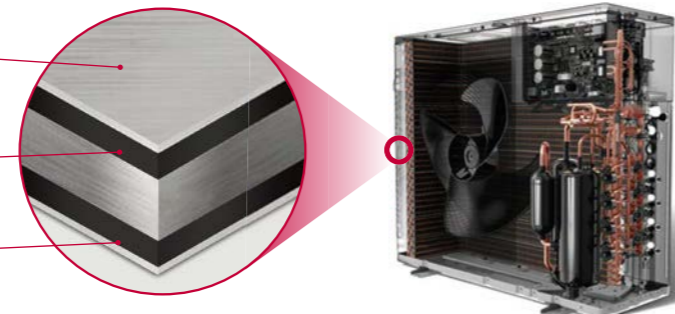

Smart Load Control

• What is Smart Load Control?

Loads and discharge air temperature will be automatically changed according to outdoor and setting temperature. ODU changes refrigerant temperature with responding to setting temperature and outdoor temperature. It will control discharge air temperature inside and reduce load of compressor.

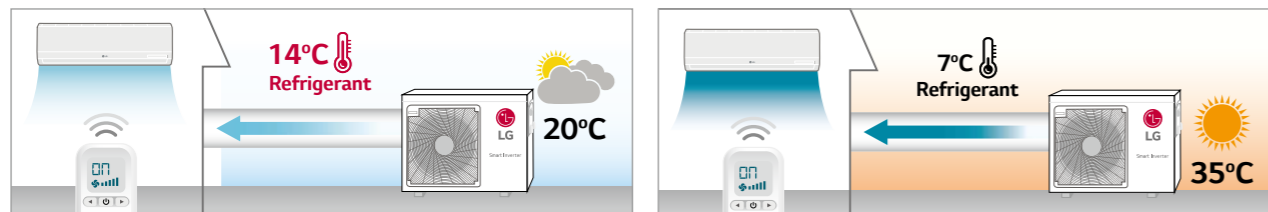

* 24K, 36K Outdoor Only

OUTDOOR UNITS KEY FEATURES

Peak Current Control

The peak current control function keeps the air conditioner from running at the maximum level while maintaining current system setting, in order to reduce energy consumption. This function can help to cut energy costs during the peak periods of energy use when the energy fee is much higher.

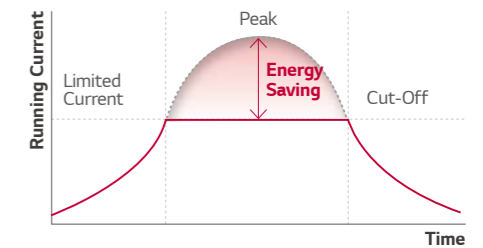

Quick Response

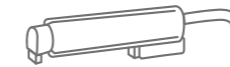

Conventional

- Step 1 Sensing current temperature of refrigerant, indoor and outdoor temperature
- Step 2 **Estimating Pressure**
Finding recorded target pressure to operate compressor, based on the corresponding temperature data

This algorithm is more likely to be impacted by temperature change and it takes more time to calculate proper operation range of compressor to target point.

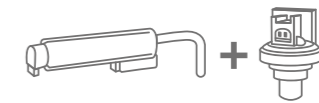

LG Inverter

- Step 1 Sensing refrigerant pressure and temperature simultaneously to make sure compressor ready for target cooling operation

This ensures to reach target performance point without failing to keep a reliable operation.

SIMs (Smart Inverter Monitoring System)

• What is the LG SIMs?

By connecting SIMs chip, you can check the status of your air conditioner and diagnose problems from your smartphone.



• How It Works

- LG SIMs SIMs App**
- 1. Use a SIMs chip to connect a smartphone to an air conditioner.
- 2. Monitor and diagnose problems in real time using the SIMs app.

• How It Works

- Easy Monitoring**
Diagnose problems anytime, anywhere with a SIMs chip.
- Easy Diagnosis & Quick Response**
Easily monitor IDU/ODU and diagnose problems. Save and review diagnostic data.

MULTI STANDARD

INDOOR UNITS

STANDARD



INDOOR UNIT				AMNW09GSJAA	AMNW12GSJAA	AMNW18GSKAA	AMNW24GSKAA
Power Supply		V, Ø, Hz		220-240, 1, 50	220-240, 1, 50	220-240, 1, 50	220-240, 1, 50
				220, 1, 60	220, 1, 60	220, 1, 60	220, 1, 60
Capacity	Cooling	kW		2.5	3.5	5.0	6.6
	Heating	kW		3.2	3.8	5.8	7.5
Power Input		W x No.		30	30	60	60
Running Current		A		0.20	0.20	0.40	0.40
Casing Color		-	Munsell 7.5BG 10/2 (RAL 9016)				
Dimensions	Body	W x H x D	mm	837 x 308 x 189	837 x 308 x 189	998 x 345 x 210	998 x 345 x 210
		W x H x D	inch	32-15/16 x 12-1/8 x 7-7/16	32-15/16 x 12-1/8 x 7-7/16	39-9/32 x 13-19/32 x 8-9/32	39-9/32 x 13-19/32 x 8-9/32
	Shipping	W x H x D	mm	909 x 383 x 256	909 x 383 x 256	1,080 x 422 x 281	1,080 x 422 x 281
		W x H x D	inch	35-25/32 x 15-3/32 x 10-3/32	35-25/32 x 15-3/32 x 10-3/32	42-17/32 x 16-5/8 x 11-1/16	42-17/32 x 16-5/8 x 11-1/16
Weight	Body	kg (lbs)		8.5 (18.7)	8.5 (18.7)	11.6 (25.6)	12.5 (27.6)
	Shipping	kg (lbs)		11.0 (24.3)	11.0 (24.3)	14.6 (32.2)	15.8 (34.8)
Heat Exchanger	(Row x Column x Fins per inch) x No.	-		(2 x 15 x 21) x 1	(2 x 15 x 21) x 1	(2 x 16 x 20) x 1 + (1 x 8 x 22) x 1	(2 x 16 x 20) x 1 + (1 x 8 x 22) x 1
	Face Area	m ² (ft ²)		0.19 (2.05)	0.19 (2.05)	0.28 (3.01)	0.28 (3.01)
Fan	Type	-		Cross Flow Fan	Cross Flow Fan	Cross Flow Fan	Cross Flow Fan
	Air Flow Rate	H / M / L	m ³ /min	9.2 / 7.4 / 5.6	9.6 / 8.1 / 5.6	14.2 / 11.3 / 9.9	15.2 / 12.7 / 10.2
		H / M / L	ft ³ /min		325 / 261 / 198	339 / 286 / 198	501 / 399 / 350
Fan Motor	Type	-		BLDC	BLDC	BLDC	BLDC
	Output	W x No.		30 x 1	30 x 1	60 x 1	60 x 1
Sound Pressure Level		H / M / L	dB(A)	36 / 33 / 27	40 / 35 / 27	44 / 38 / 35	46 / 41 / 36
Sound Power Level		Max.	dB(A)	57	57	59	65
Piping Connections	Liquid	mm(inch)		Ø 6.35 (1/4)	Ø 6.35 (1/4)	Ø 6.35 (1/4)	Ø 6.35 (1/4)
	Gas	mm(inch)		Ø 9.52 (3/8)	Ø 9.52 (3/8)	Ø 12.7 (1/2)	Ø 12.7 (1/2)
	Drain	O.D. / I.D.	mm	Ø 21.5 / 16.0	Ø 21.5 / 16.0	Ø 21.5 / 16.0	Ø 21.5 / 16.0
Safety Devices		-		Fuse			
		-		Thermal Protector for Fan Motor			
Connections Method		-		Flared	Flared	Flared	Flared
Power and Communication Cable (included Earth)		No. x mm ² (AWG)		4C x 1.0 (18)	4C x 1.0 (18)	4C x 1.0 (18)	4C x 1.0 (18)

Note

1. Due to our policy of innovation some specifications may be changed without notification.
2. Wiring cable size must comply with the applicable local and national code. And "Electric characteristics" chapter should be considered for electrical work and design. Especially the power cable and circuit breaker should be selected in accordance with that.
3. Sound Level Values are measured at Anechoic chamber. Therefore, these values depend on the ambient conditions and values are normally higher in actual operation.
4. Capacities are net capacities and based on the following conditions. Refer to the Outdoor Unit Specifications for calculating the real capacity.
 - Cooling : Indoor Ambient Temp. 27°CDB / 19°CWB, Outdoor Ambient Temp. 35°CDB / 24°CWB
 - Heating : Indoor Ambient Temp. 20°CDB / 15°CWB, Outdoor Ambient Temp. 7°CDB / 6°CWB
 - Interconnected Pipe is standard length and difference of Elevation (Outdoor - Indoor Unit) is Zero.

MULTI STANDARD

OUTDOOR UNITS



OUTDOOR UNIT				A2UW18GFAB	A3UW24GFAB	A3UW36GFAB
Cooling Capacity*			kW	5.39	7.33	10.5
			Btu/h	18,400	25,000	36,000
Heating Capacity*			kW	5.69	7.77	12.1
			Btu/h	19,400	26,500	41,400
Power Input	Cooling*	kW		1.61	2.19	3.23
	Heating*	kW		1.65	2.37	3.69
Power Supply		V, Ø, Hz		220-240, 1, 50	220-240, 1, 50	220-240, 1, 50
		V, Ø, Hz		220, 1, 60	220, 1, 60	220, 1, 60
Running Current	Cooling*	A		7.5	10.1	14.7
	Heating*	A		7.6	11.0	16.8
Power Factor		Rated	-	0.94	0.94	0.96
Power Supply Cable (included Earth)		No. x mm ²		3C x 2.5	3C x 2.5	3C x 2.5
Casing Color		-		Pigeon Gray	Warm Gray	Warm Gray
Dimensions		W x H x D	mm	770 x 545 x 288	870 x 655 x 320	950 x 834 x 330
Net Weight		kg (lbs)		37.0 (81.6)	45.0 (99.2)	61.0 (134.4)
Shipping Weight		kg (lbs)		40.0 (88.2)	49.0 (108.0)	68.0 (149.9)
Compressor	Type	-		Twin Rotary	Twin Rotary	Twin Rotary
	Motor type	-		BLDC	BLDC	BLDC
Precharged Amount		g (oz)		1,400 (49.4)	1,700 (60.0)	3,200 (112.9)
Control		-		Electronic Expansion Valve	Electronic Expansion Valve	Electronic Expansion Valve
Chargeless-Pipe Length		m (ft)		20 (65.6)	22.5 (73.8)	37.5 (123.0)
Additional Charging Volume		g/m (oz/ft)		20 (0.22)	20 (0.22)	20 (0.22)
Refrigerant Oil	Type	-		RB68A	RB68A	FVC68D
	Charged volume	cc x No.		400 x 1	400 x 1	900 x 1
Fan	Type	-		Propeller	Propeller	Propeller
	Air Flow Rate	m ³ /min x No.		28.2 x 1	50 x 1	60 x 1
Fan Motor	Type	-		BLDC	BLDC	BLDC
	Output	W x No.		43 x 1	85.4 x 1	124.2 x 1
Sound Pressure Level	Cooling	Rated	dB(A)	48	50	50
	Heating	Rated	dB(A)	51	54	54
Sound Power Level		Max.	dB(A)	63	64	66
Piping Connections	Liquid	Outer Dia. x No.	mm(inch)	Ø 6.35(1/4) x 2	Ø 6.35 (1/4) x 3	Ø 6.35 (1/4) x 3
	Gas	Outer Dia. x No.	mm(inch)	Ø 9.52(3/8) x 2	Ø 9.52 (3/8) x 3	Ø 9.52 (3/8) x 3
Piping Length	Total Piping	Max.	m (ft)	30 (98.4)	50 (164.0)	75 (246.1)
	Each Branch	Standard	m (ft)	7.5 (24.6)	7.5 (24.6)	7.5 (24.6)
		Max.	m (ft)	20 (65.6)	25 (82.0)	25 (82.0)
Maximum Height Difference	ODU-IDU	Max.	m (ft)	15 (49.2)	15 (49.2)	15 (49.2)
	IDU-IDU	Max.	m (ft)	7.5 (24.6)	7.5 (24.6)	7.5 (24.6)
Operation Range (Outdoor Temperature)	Cooling	Min. - Max.	°C(°F)DB	-10 (14.0) - 48 (118.4)	-10 (14.0) - 48 (118.4)	-10 (14.0) - 48 (118.4)
	Heating	Min. - Max.	°C(°F)WB	-18 (-0.4) - 18 (64.4)	-18 (-0.4) - 18 (64.4)	-18 (-0.4) - 18 (64.4)

Note

1. Due to our policy of innovation some specifications may be changed without notification.
2. Wiring cable size must comply with the applicable local and national codes. And "Electric characteristics" chapter should be considered for electrical work and design. Especially the power cable and circuit breaker should be selected in accordance with that.
3. Power factor could vary less than ±1% according to the operating conditions.
4. Sound pressure level is measured on the rated condition in the anechoic rooms by ISO 3745 standard.
 - Sound power level indoors is measured on the rated condition in the reverberation rooms by ISO 3741 standard. Therefore, these values can be increased owing to ambient conditions during operation.
5. Performances are based on the following conditions :
 - *Cooling : Indoor Ambient Temp. 27°CDB / 19°CWB, Outdoor Ambient Temp. 35°CDB / 24°CWB
 - *Heating : Indoor Ambient Temp. 20°CDB / 15°CWB, Outdoor Ambient Temp. 7°CDB / 6°CWB
 - Interconnected Pipe is standard length and difference of Elevation (Outdoor - Indoor Unit) is Zero.
6. This product contains Fluorinated greenhouse gases.